

Hardy-Rib Installation Manual



“Nationwide supplier of quality metal roofing.”

G3336 S Dort Hwy.
Burton, MI 48529

● midmichiganmetalsales.com ●

Toll-Free
(800) 615-8416

IMPORTANT NOTICE

This manual contains suggestions and guidelines on how to install Mid Michigan Hardy Rib panels and trim details. The contents of this manual include the guidelines that were in effect at the time this publication was originally printed. In an effort to keep pace with the ever-changing code environment, Mid Michigan Metal Sales retains the right to change specifications and/ or designs at any time without incurring any obligations. To insure you have the latest information available, please inquire or visit our web site. Application and design details are for illustrative purposes only and may not be appropriate for all environmental conditions and/or building designs. Projects should be engineered and installed to conform to applicable building codes, regulations, and accepted industry practices.

**Disclaimer: This information is provided "as is" and is intended for entertainment purposes only. The author, publishers and marketers of this information disclaim any loss or liability, either directly or indirectly as a consequence of applying the information presented herein, or in regard to the use and application of said information. No guarantee is given, either expressed or implied, in regard to the merchantability, accuracy, or acceptability of the information.*

TABLE OF CONTENTS

1. Introduction - Design and Testing

2. Panel Installation

a. Installation Guide

b. Panel Squaring

3. Installation Sequence

4. Trim Assemblies

a. Fascia

b. Drip Edge

c. Rake / Gable

d. Preformed Valley

e. Transition/Pitch Break

f. Gambrel

g. Hip

h. Ridge

i. Vented Ridge

j. High Side Peak

k. Side Wall

l. End Wall

5. Special Details

a. Valley Lapping and Cutting

b. Pipe Flashing

Introduction

The Hardy-Rib panel is an industry leader in strength and durability. This popular and versatile panel features classic looks and is used in a wide range of applications including residential, commercial, and post-frame buildings. Hardy-Rib was designed with strong trapezoidal ribs to increase strength and ease handling and installation. In addition, the anti-siphoning channel on the under-lap provides extra leak resistance in the presence of extreme wind and rain loads.

Hardy Rib is available in many different paint colors in AZ50 29 gauge steel. It is also available in unpainted Galvalume®. Our paint system and Galvalume® substrate are individually covered by a limited warranty.

The Hardy Rib panel has a 36” coverage. The panel has five major support ribs at ¾” high that add rigidity and strength to the panel.

Allowable Uniform Loads Per Square Foot

SPAN (INCHES)	LIVE LOAD (PSF)						WIND LOAD (PSF)					
	18”	24”	30”	36”	48”	54”	18”	24”	30”	36”	48”	54”
29 Gauge	199	112	71	49	28	22	211	118	76	52	29	23

NOTES:

1. Theoretical allowable loads are based on section properties and allowables calculated in accordance with 2001 AISI Specifications.
2. Theoretical allowable loads are based on three or more uniform spans.
3. For roof panels, deduct self weight for actual 'live load' capacity of the panel.
4. These loads are for panel strength. Frames, purlins, decks and fasteners must be designed to resist all loads imposed on the panel.
5. Check local building codes if panel testing is required.

Panel Installation Guide

Storage

If metal is not to be used immediately, store inside in a well ventilated, dry location. Condensation or other moisture can form between the sheets during storage causing water stains or white rust which detract from the appearance of the product and may affect the product's useful life. Trapped moisture between sheets of painted metal can cause white rust to form underneath the paint. This can cause the paint to flake off the panel immediately or several years later. To prevent white rust and staining, break the shipping bands on the material. Store the material on end or on an incline of at least 8° with a supporting board underneath to prevent sagging. Fan the sheets slightly at the bottom to allow for air circulation. Keep the sheets off of the ground with an insulator such as wood. Any outdoor storage is at the customer's own risk. If outdoor storage cannot be avoided, protect the metal using a canvas cover or waterproof paper. Never cover the metal with plastic as this will cause condensation to form.

Some Safety Precautions

Always wear protective gloves when working with steel panels to avoid cuts from sharp edges. When cutting or drilling steel panels, always wear safety glasses and sweep off any metal shavings immediately to prevent eye injury from flying metal fragments. If you must walk on a metal roof, take great care. Metal panels can become slippery, so always wear shoes with non-slip soles. Avoid working on metal roofs during wet conditions when the panels can become extremely slippery.

General Installation Information

Insure that the structure is square and true before beginning panel installation. If the structure is not square, the panels will not properly seal at the sidelaps. Start the first panel square to eave by using the 3, 4, 5 Triangle Method. Green or damp lumber is not recommended. Moisture released from the damp lumber may damage the metal panels. Nails installed in green or damp lumber may back out. Remove any loose metal shavings left on the roof surface immediately to prevent corrosion. After installing roof, remove any debris such as leaves or dirt to prevent moisture from getting trapped on panels.

Fastening

If you wish to predrill fastener holes, use a cover sheet to prevent hot shavings from sticking to panels. Screws - For best results, use a 1-1/2" Kwikseal Woodbinder washered wood screw in the flat of the panel as shown in the illustration below. Drive the fastener so that the washer is compressed securely against the metal. Do not over drive the fastener as this will form a dimple that can collect water and cause leakage. Do not leave any loose fasteners that have missed the purlin. Use Novaflex or equivalent sealant to seal the hole.

Figure #1 - Fastening Patterns for Hardy Rib

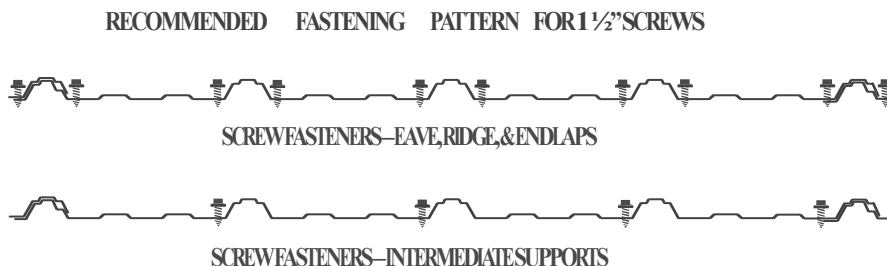

Figure #3



Roofing

Slopes of less than 2" on 12" are not recommended. For slopes of 2" on 12" or greater, end lap panels 6". Side laps should face away from the prevailing wind. Lay the first sheet along the eave at the down-wind side of the roof, farthest away from the direction of the prevailing winds (See Figure #4). Install sheets in the sequence shown in Figure #4.

Figure #4

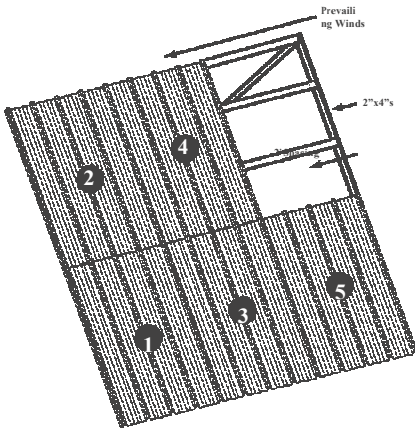

Maximum Purlin Spacing for Roof 2' on Center

Figure #5 - Installation Options

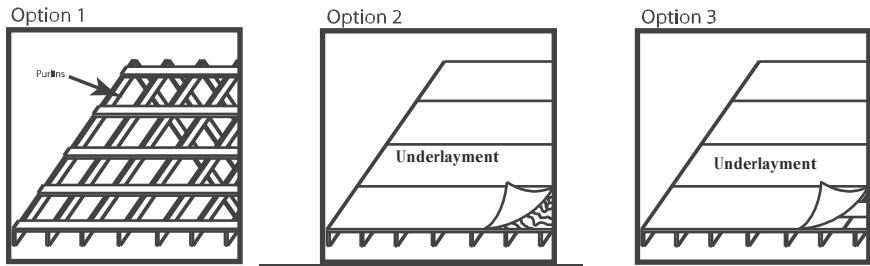

Install Metal Directly to Wood Frame

- Use Maximum 2' Purlin Spacing
- Install Metal
- *NOT RECOMMENDED FOR HEATED SPACES UNLESS INSULATION AND VAPOR BARRIER PROTECTION IS USED

Install Metal on Solid Deck

- Lay Plywood Deck
- Apply Synthetic Underlayment or other Vapor Barrier Protection
- Install Metal

Install Metal Over Existing Shingles

- Apply Synthetic Underlayment or other Vapor Barrier Protection
- Install Metal

* Proper ventilation and vapor barrier protection recommended for heated spaces

Allow an overhang a minimum of 1" at the eave to provide for a drip edge. Use inside closure at eave to prevent water infiltration, insect or bird infestation at openings. To protect against uplifting winds and to provide a finished appearance, apply gable trim. Apply fasteners every 24". Optionally apply butyl tape as shown in Figure #6 along the top of lap ribs. Do not block the siphon channel with the tape. Also an option: apply a 1-1/2" lap stitch screw into the crown of the rib to secure the side lap. This is especially a good idea on roofs with a slope less than 4:12.

Figure #6 - Proper Application of Side Lap Butyl Tape



Allowable Uniform Loads Per Square Foot

SPAN (INCHES)	LIVE LOAD (PSF)						WIND LOAD (PSF)					
	18"	24"	30"	36"	48"	54"	18"	24"	30"	36"	48"	54"
29 Gauge	199	112	71	49	28	22	211	118	76	52	29	23

NOTES:

1. Theoretical allowable loads are based on section properties and allowables calculated in accordance with 2001 AISI Specifications.
2. Theoretical allowable loads are based on three or more uniform spans.
3. For roof panels, deduct self weight for actual 'live load' capacity of the panel.
4. These loads are for panel strength. Frames, purlins, decks and fasteners must be designed to resist all loads imposed on the panel.
5. Check local building codes if panel testing is required.

3...4...5...Triangle Method

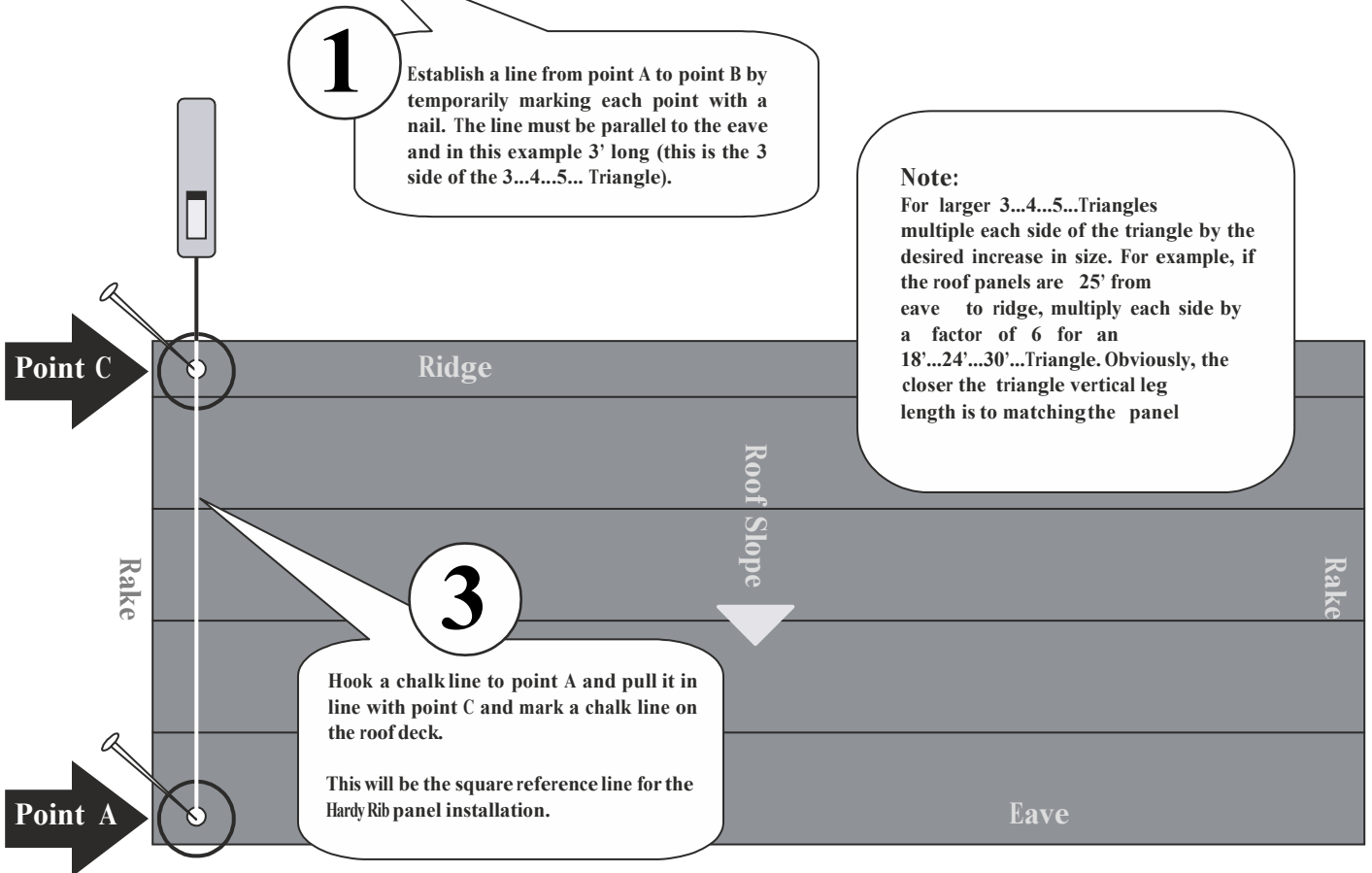
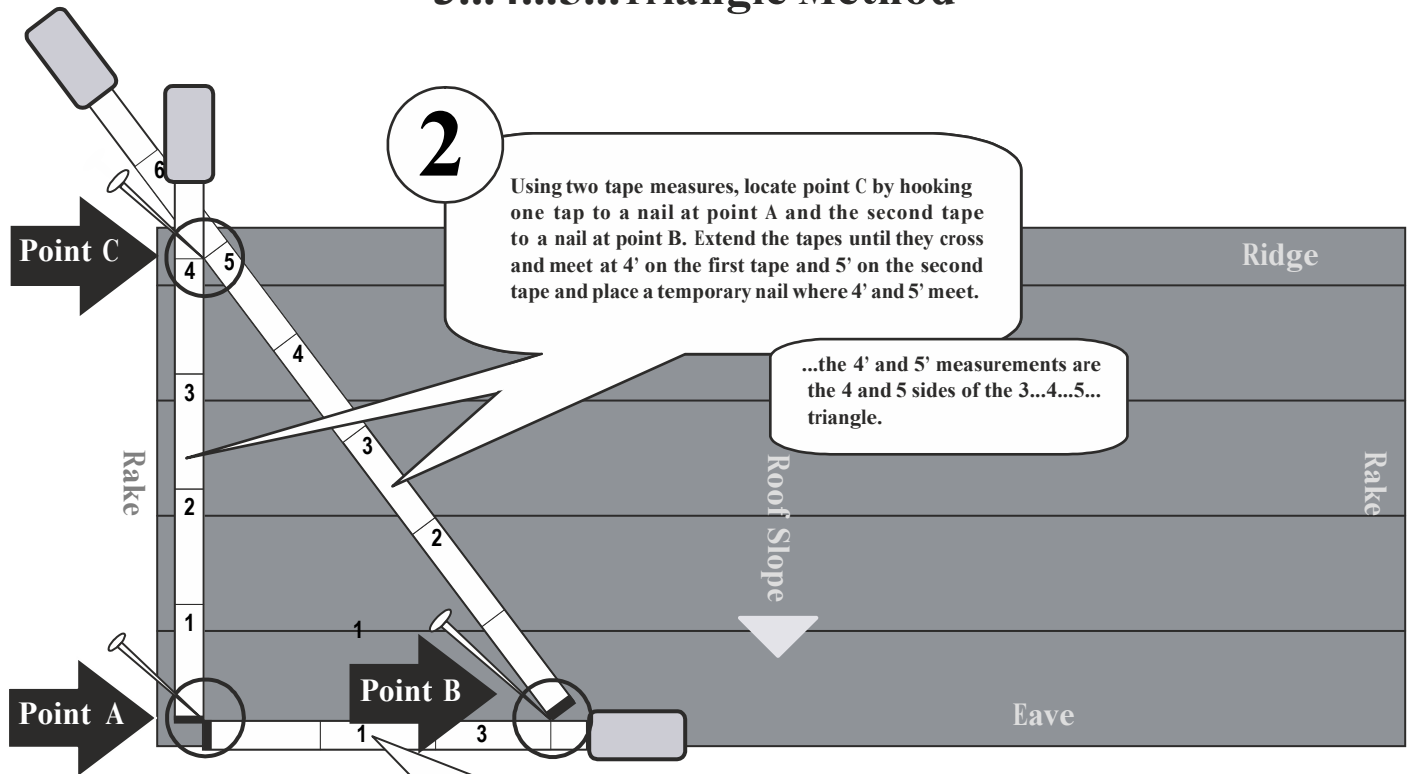

3...4...5...Triangle Method

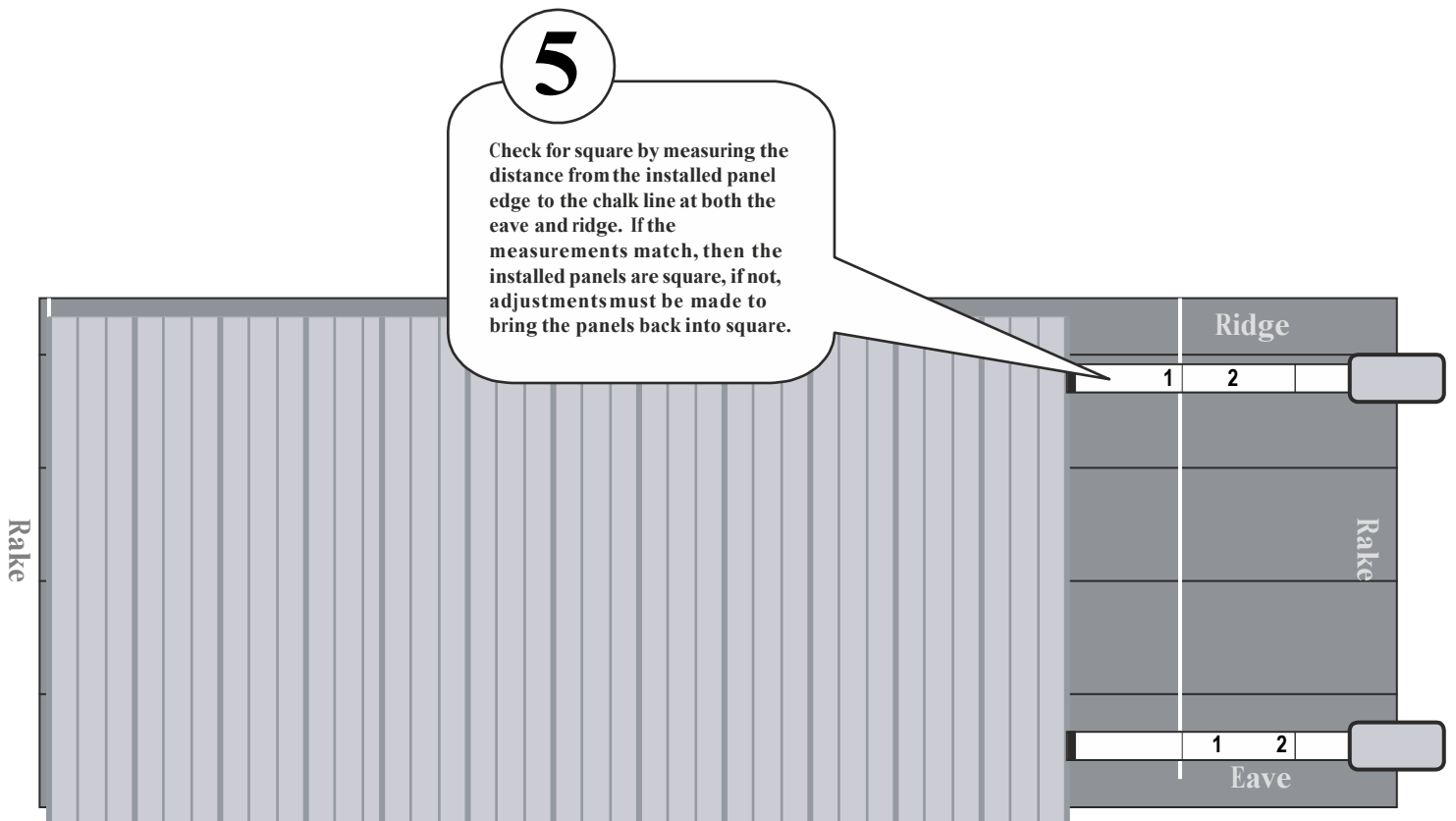
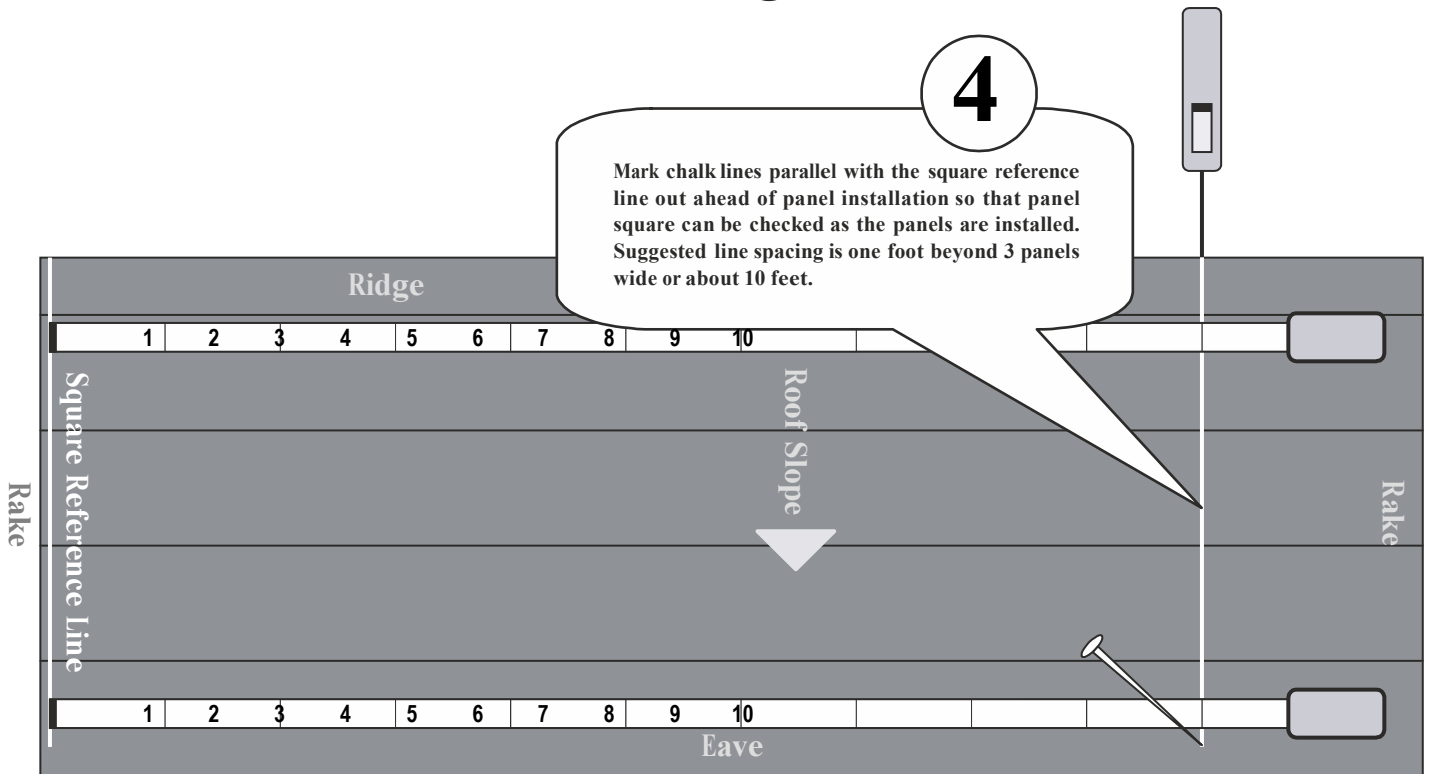

Installation Sequence

The following is an example of a typical sequence for the installation of Hardy Rib panels and trims and is specific to the roof plan and conditions illustrated. The actual sequence may vary based on the specific roof plan and applicable conditions.

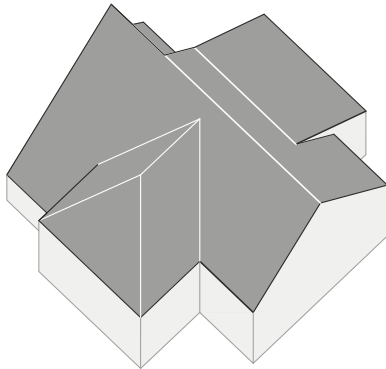

1. Moisture Barrier

Install the Moisture Barrier per the manufacturer's recommended procedure.

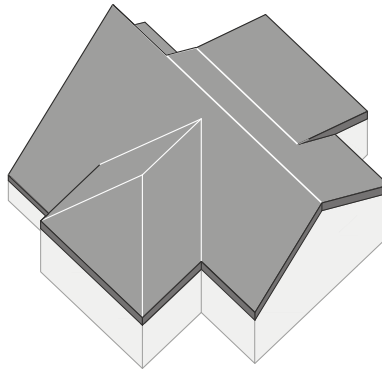

2. Fascia Trim (optional)

Install the Fascia Trim along all eaves and rakes.

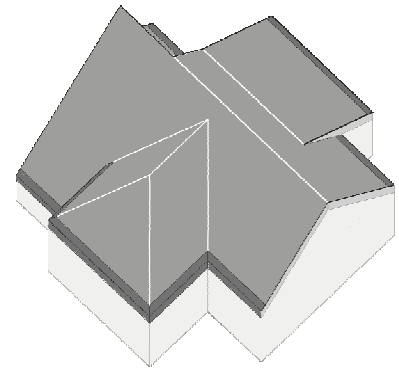

3. Drip Edge

Install the drip edge along all eaves lapping over the Fascia Trim.

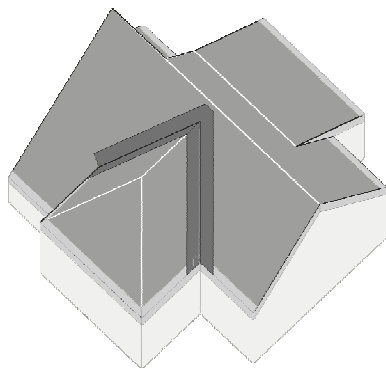

4. Valley Trim

Install the Valley Trim over the Drip Edge working from the eave to the valley peak.

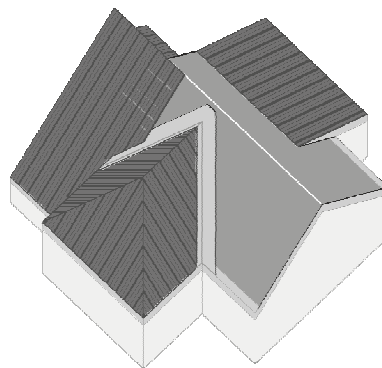

5. Hardy Rib Panels

Install the panels over the Eave and Valley Trims. Do not install panels where the Ridge Trim laps under the panels.

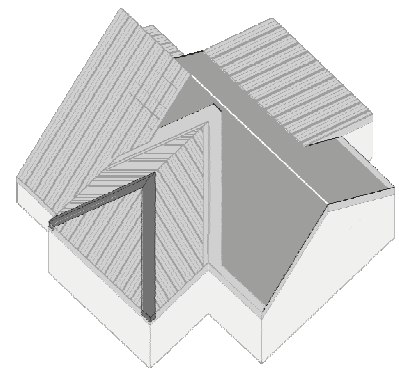

6. Hip Trim

Install the Hip Trim over the panels.

Installation Sequence

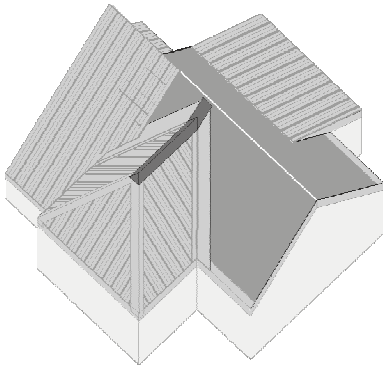

7. Ridge Trim
Install the Ridge Trim over the Hip Trim intersection and valley peak.

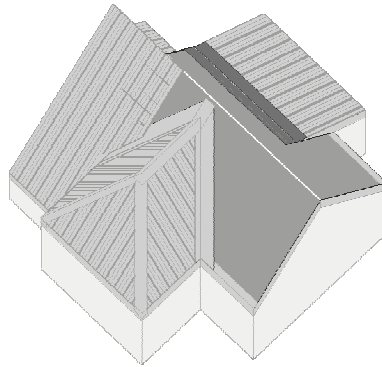

8. Transition Trim
Install the Transition Trim over the low slope panels and moisture barrier.

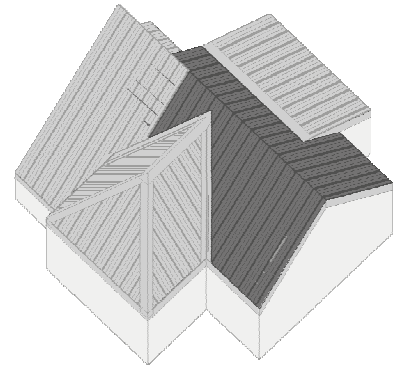

9. Hardy Rib Panels Complete the panel installation installing the high slope panels over the Trim Transition and the other remaining exposed locations.

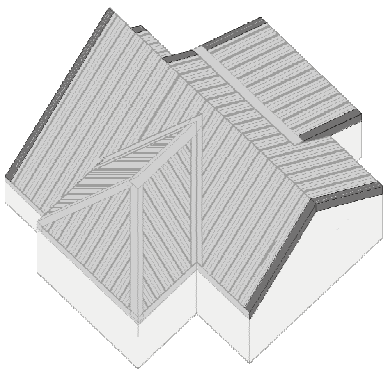

10. Gable / Rake Trim
Install the Rake Trim over the panels along all rake (gable) edges.

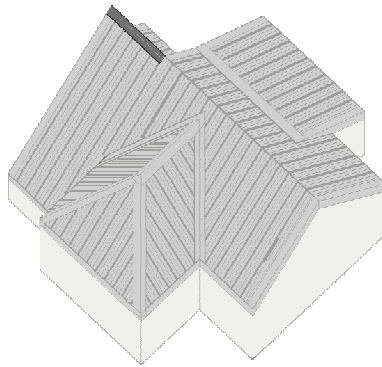

11. High Side Peak Trim
Install the High Side Peak Trim over the panels.

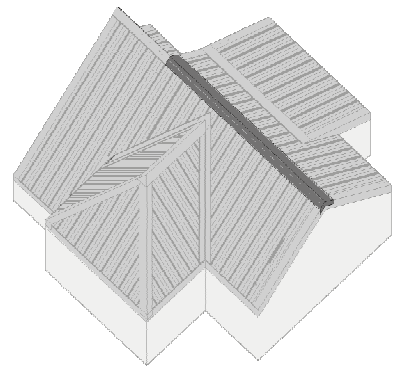

12. Ridge Cap
Install the Ridge Cap over the panels.

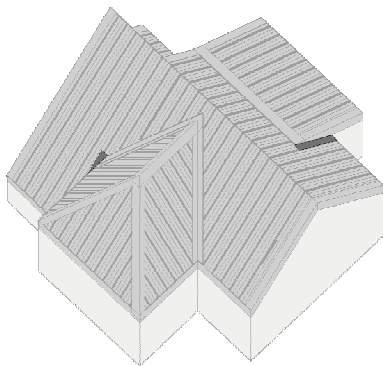

13. Side Wall Trim
Install the Side Wall Trim over the panels.

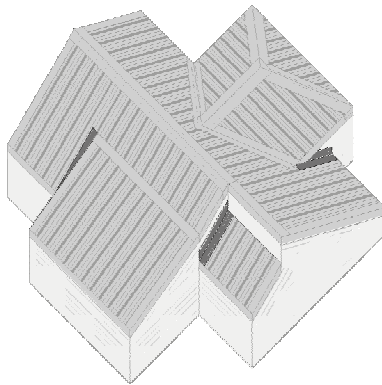

14. Side Wall Trim (Rear View)
Install the Side Wall Trim over the panels.

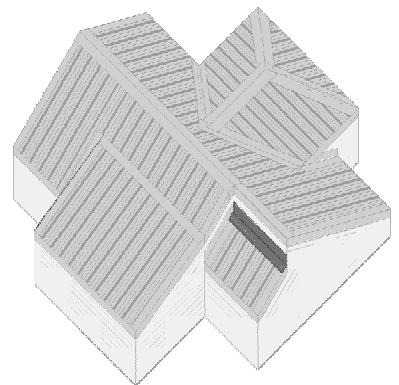

15. End Wall Trim
Install the End Wall Trim over the panels.

Fascia

Numbers indicate suggested trim assembly sequence.

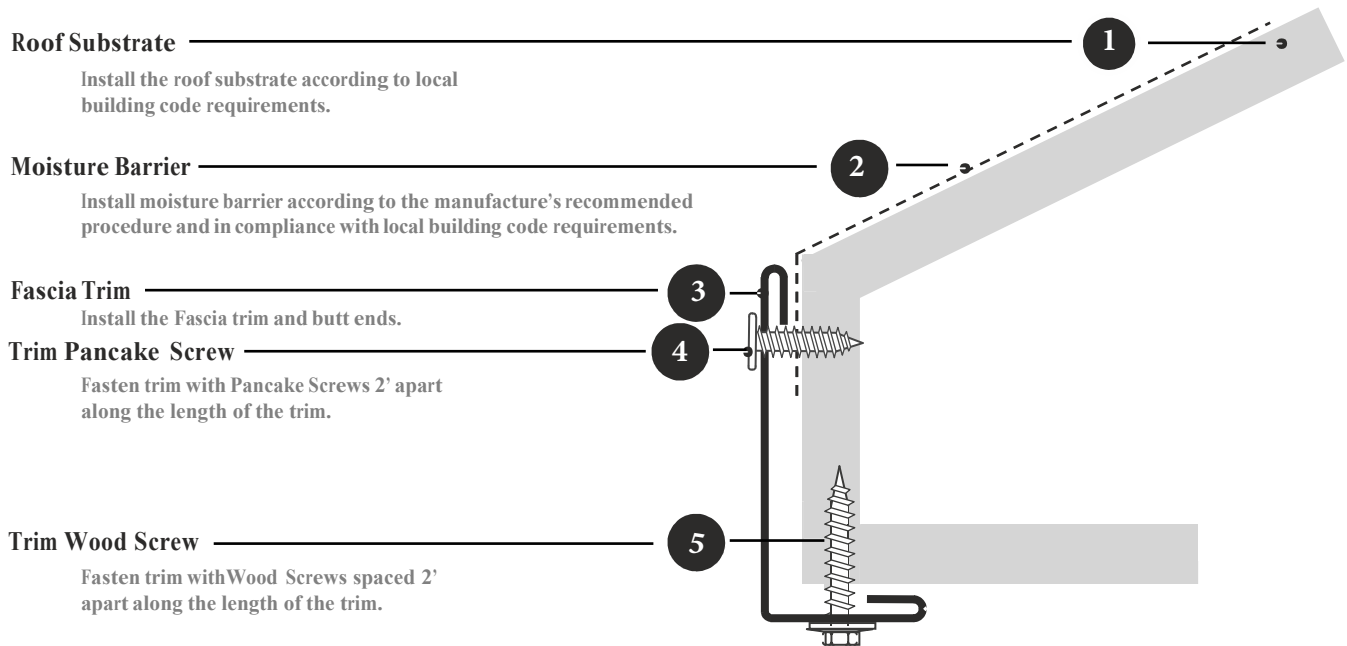
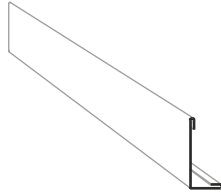

Drip Edge

Numbers indicate suggested trim assembly sequence.

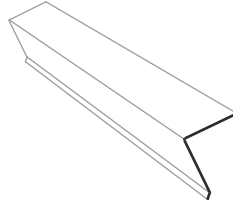

Moisture Barrier

Install moisture barrier according to the manufacture's recommended procedure and in compliance with local building code requirements.

2

Trim Pancake Screw

Fasten trim with Pancake Screws spaced 2' apart along the length of the trim.

4

Drip Edge

Install the Drip Edge and butt ends.

3

Roof Substrate

Install the roof substrate according to local building code requirements.

1

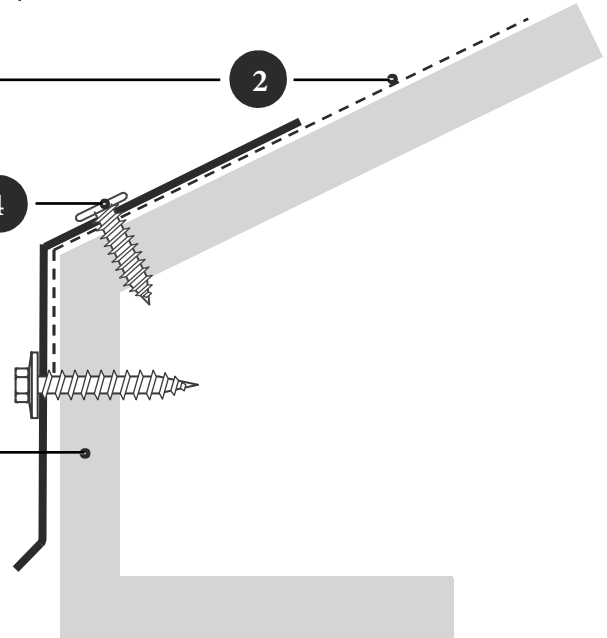

Panel Wood Screw

Fasten panels to the roof substrate using Wood Screws spaced according to the recommended fastening pattern and frequency, and in compliance with local building codes.

7

Hardy Rib Panels

Install the panel and overhang the panel a minimum of 1" beyond the Drip edge. See panel squaring method in this manual.

6

Inside Closure

Place the Inside Closure down over the drip edge or underlayment.

5

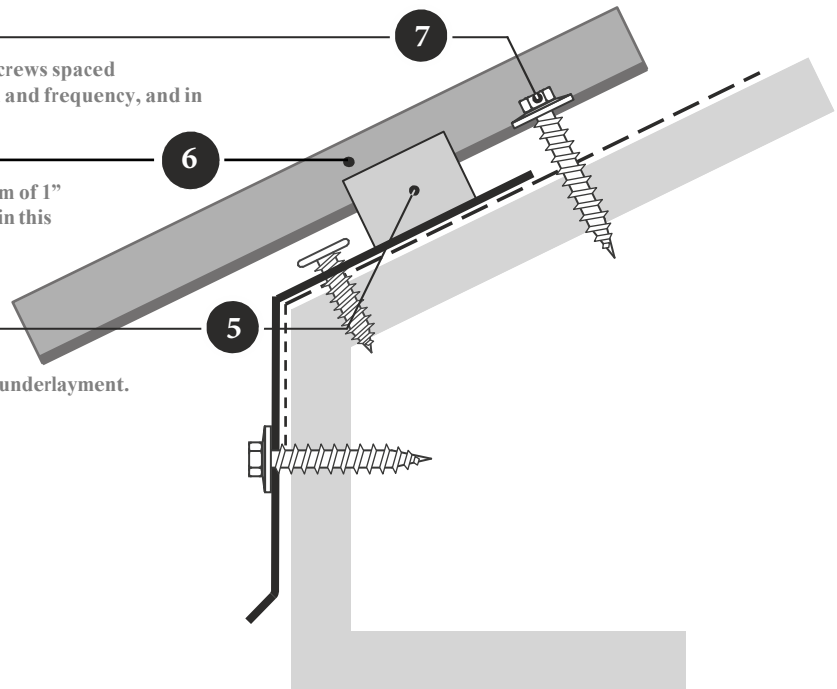

Rake / Gable

Numbers indicate suggested trim assembly sequence.

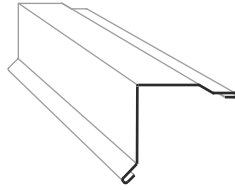

Tape Sealant

Apply Butyl Tape along the length of the panel.

Hardy Rib Panels

Install the panel and overhang the panel a minimum of 1" beyond the Drip edge. See panel squaring method in this manual.

Panel Wood Screw

Fasten panels to the roof substrate using Wood Screws spaced according to the recommended fastening pattern and frequency, and in compliance with local building codes.

Moisture Barrier

Install moisture barrier according to the manufacture's recommended procedure and in compliance with local building code requirements.

Roof Substrate

Install the roof substrate according to local building code requirements.

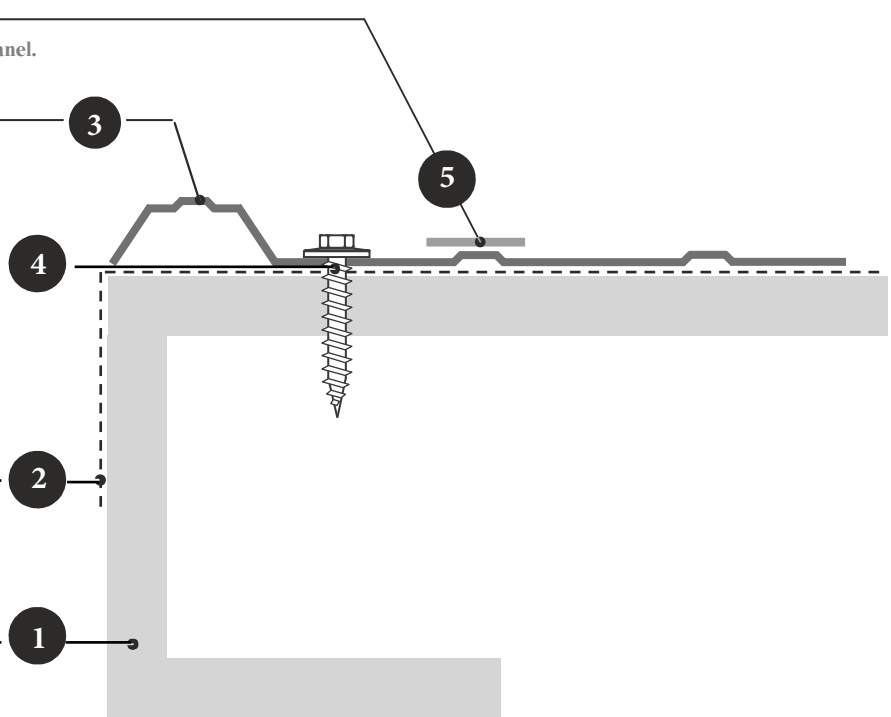

Rake / Gable Trim

Install the Rake trim and overlap the ends 4". See lapping diagram in this manual.

Trim Wood Screw

Fasten trim with Wood Screws spaced 2' apart along the length of the trim.

Trim Wood Screw

Fasten trim with Wood Screws spaced 2' apart along the length of the trim.

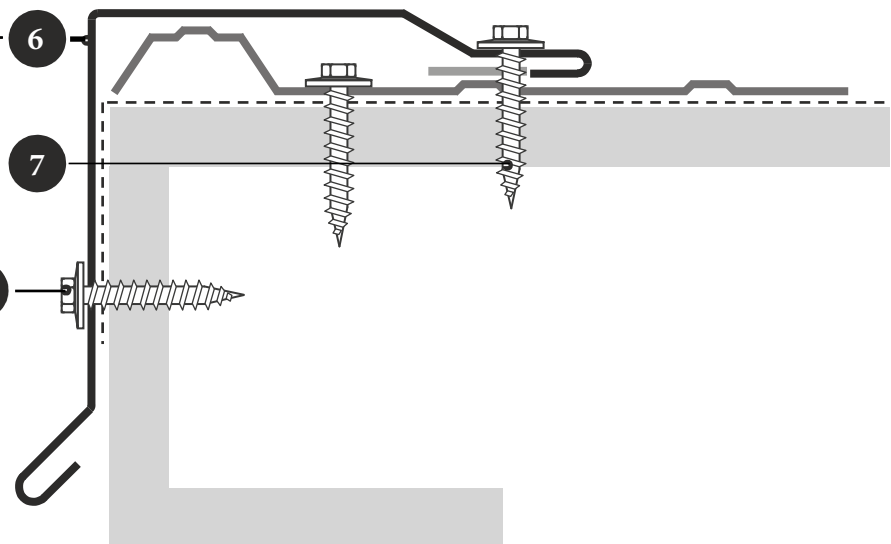

Preformed Valley

Numbers indicate suggested trim assembly sequence.

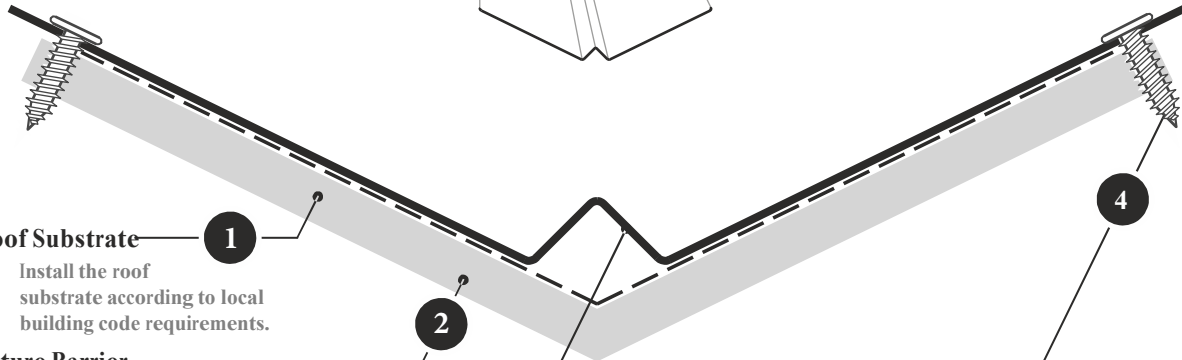
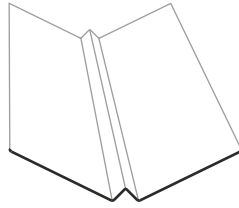

1 **Roof Substrate**

Install the roof substrate according to local building code requirements.

2

Moisture Barrier

Install moisture barrier according to the manufacture's recommended procedure and in compliance with local building code requirements.

3

Preformed Valley Trim

Install the Valley trim and overlap the ends 4". See lapping diagram in this manual.

4

Trim Pancake Screw

Fasten trim with Pancake Screws spaced 2' apart along the length of the trim. See lapping diagram fastener pattern in this manual.

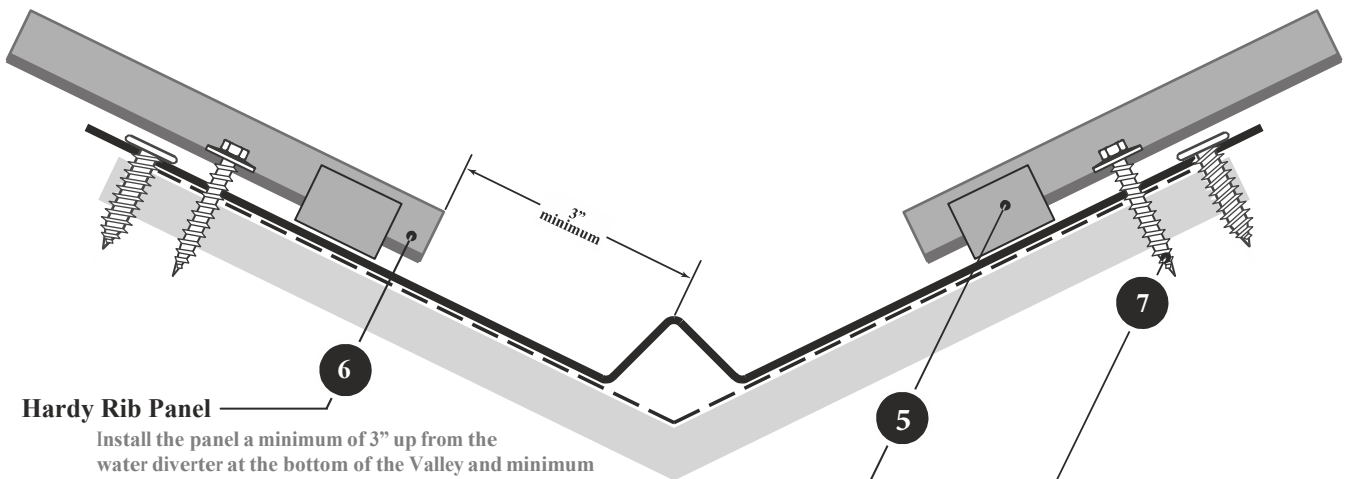

6 **Hardy Rib Panel**

Install the panel a minimum of 3" up from the water diverter at the bottom of the Valley and minimum of 3" down from the top of the Valley. See panel squaring method in this manual.

5

Expanding Closure

Place Expanding Closure parallel to each side of the Valley center water diverter. Closure should be up from the panel end about 1". See panel minimum set back above.

Notes:

- 1. See Valley Lapping - Page 25
- 2. See Valley Cutting - Page 26

7 **Panel Wood Screw**

Fasten panels to the roof substrate using Wood Screws spaced according to the recommended fastening pattern and frequency, and in compliance with local building codes.

Transition / Pitch Break

Numbers Indicate suggested trim assembly sequence.

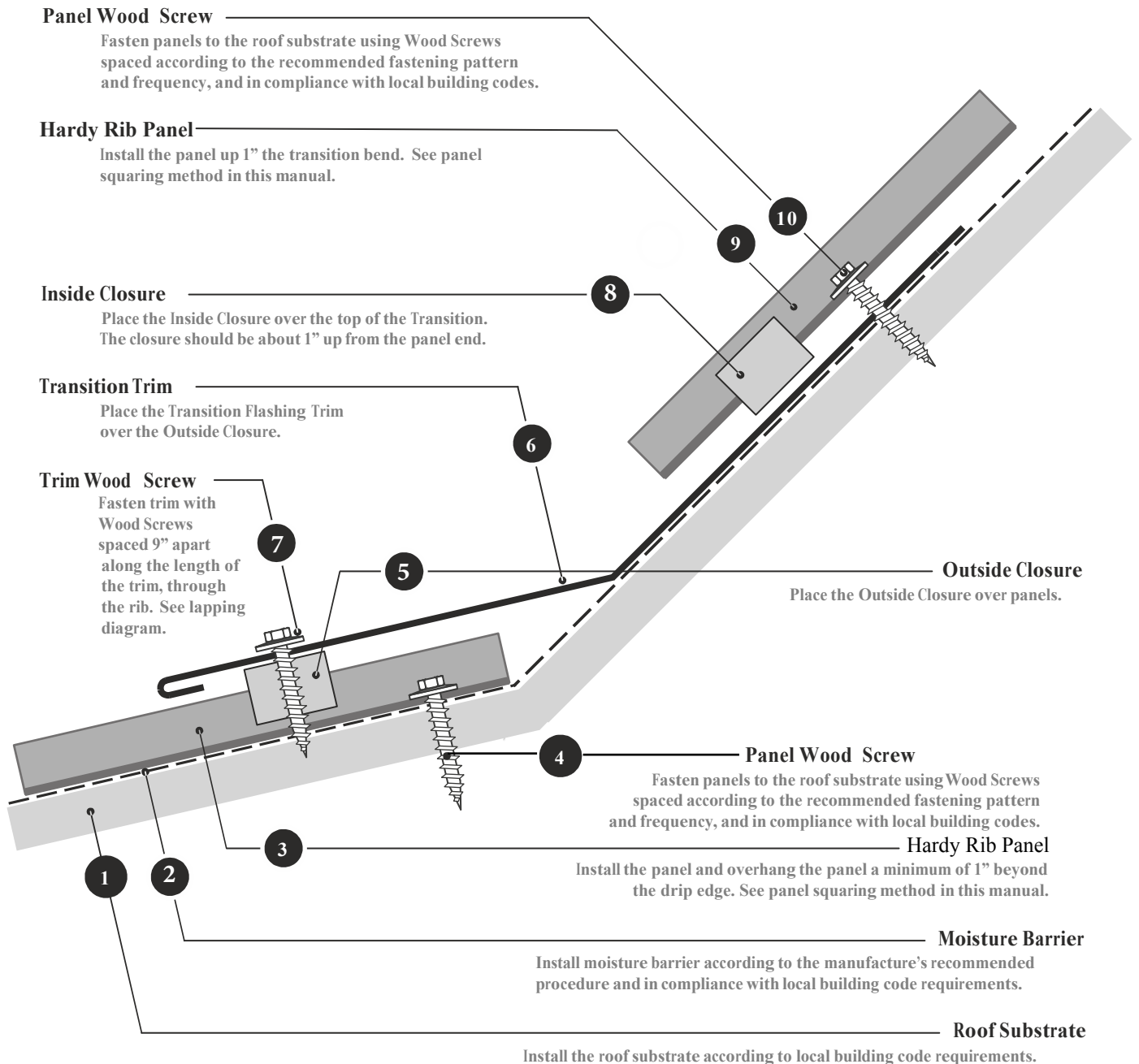
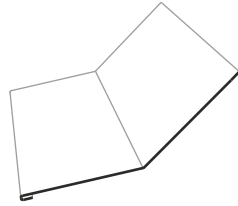

Gambrel

Numbers Indicate suggested trim assembly sequence.

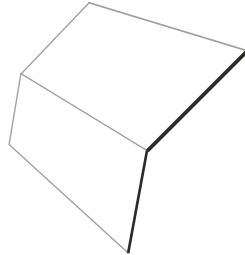

Hardy Rib Panel

Install the panel 1" beyond the transition bend. See panel squaring method in this manual.

Panel Wood Screw

Fasten panels to the roof substrate using Wood Screws spaced according to the recommended fastening pattern and frequency, and in compliance with local building codes.

Panel Wood Screw

Fasten panels to the roof substrate using Wood Screws spaced according to the recommended fastening pattern and frequency, and in compliance with local building codes.

Trim Wood Screw

Fasten trim with Wood Screws spaced 18" apart along the length of the trim, through the rib, through the rib.

Hardy Rib Panel

Install the panel and overhang the panel a minimum of 1" beyond the eave edge.

Moisture Barrier

Install moisture barrier according to the manufacturer's recommended procedure and in compliance with local building code requirements.

13

14

11

4

8

9

6

3

2

1

Inside Closure

Place the Inside Closure over the top of the Gambrel up about 1" from the panel end.

Gambrel Trim

Place the Gambrel Flashing Trim over the Outside Closure.

Outside Closure

Place the Outside Closure over the top of the panels.

Roof Substrate

Install the roof substrate according to local building code requirements.

Hip

Numbers indicate suggested trim assembly sequence.

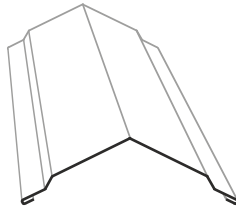

Panel Wood Screw

Fasten trim with Wood Screws spaced 9" apart along the length of the trim, through the rib. See lapping diagram fastener pattern in this manual.

Hip Trim

Place the Hip Trim over the Expanding Closure

Expanding Closure

Place Expanding closure parallel to each side of the hip center line so that hip fastener penetrates the center of the closure. Closure should be up from the panel end about 1".

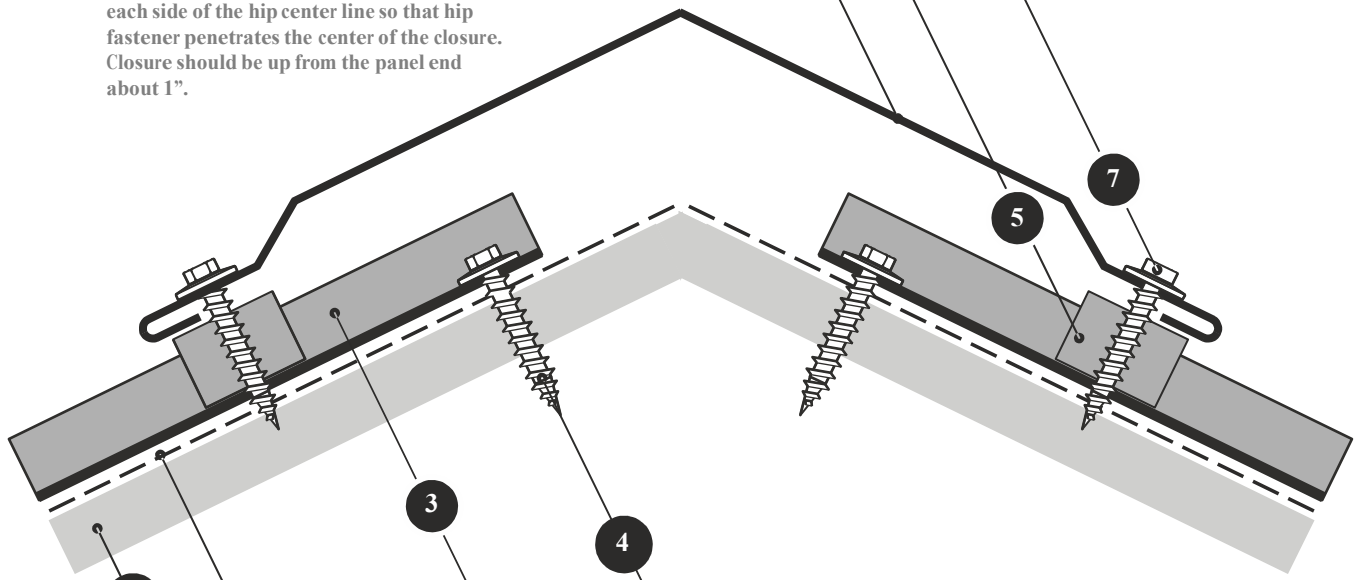

Panel Wood Screw

Fasten panels to the roof substrate using Wood Screws spaced according to the recommended fastening pattern and frequency, and in compliance with local building codes.

Hardy Rib Panel

Install the panel and overhang the panel a minimum of 1" beyond the eave edge. See panel squaring method in this manual.

Moisture Barrier

Install moisture barrier according to the manufacture's recommended procedure and in compliance with local building code requirements.

Roof Substrate

Install the roof substrate according to local building code requirements.

Ridge

Numbers Indicate suggested trim assembly sequence.

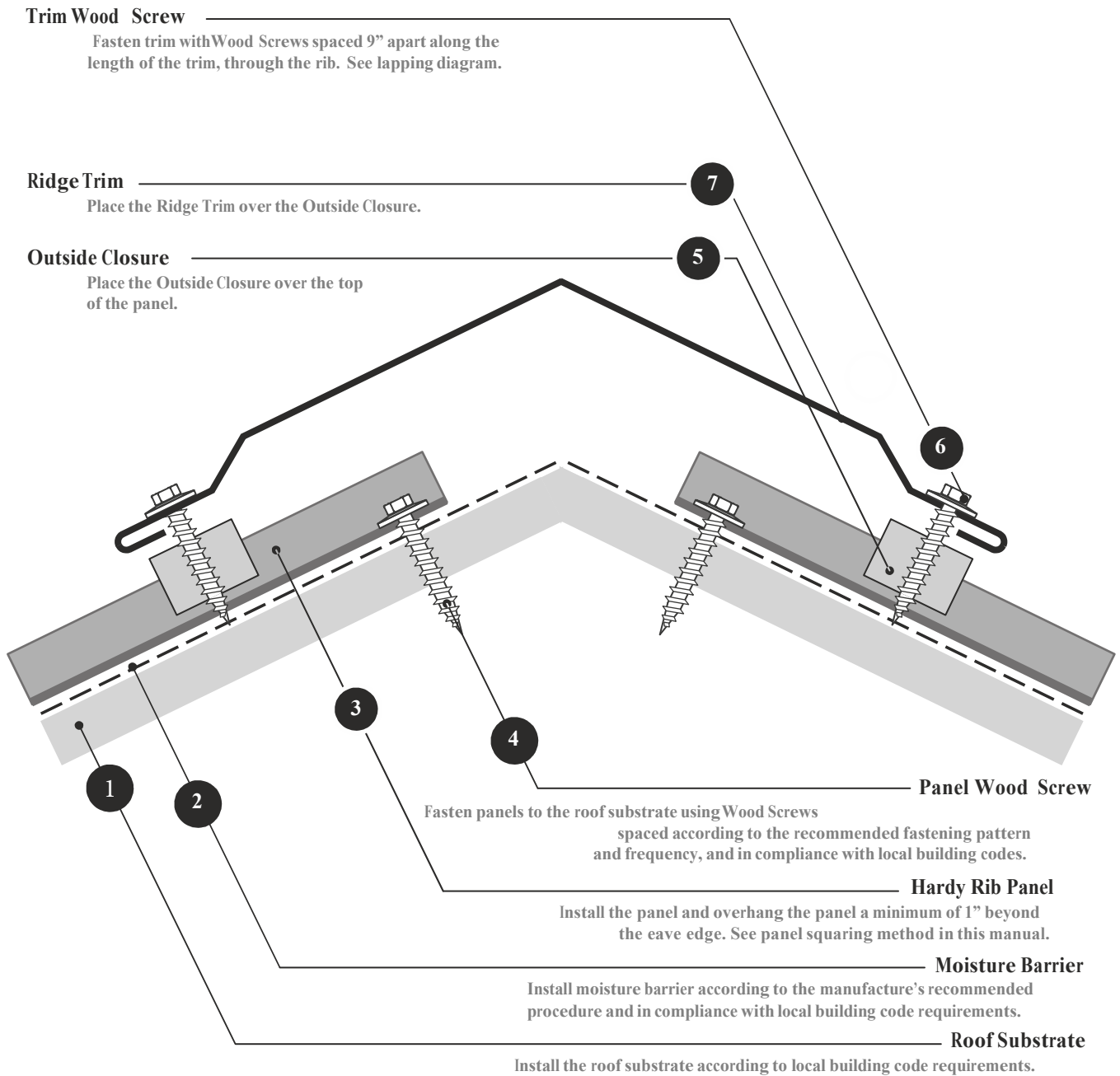
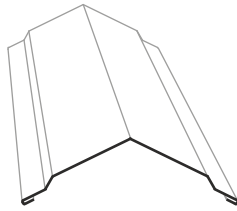

Vented Ridge

Numbers indicate suggested trim assembly sequence.

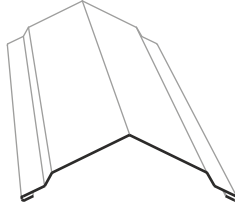

Trim Wood Screw

Fasten trim with Wood Screws spaced 9" apart along the length of the trim, through the rib. See lapping diagram fastener pattern in this manual.

Ridge Trim

Place the Ridge Trim over the Profile Vent.

Vent Material

Apply the Profile Vent ridge venting material over the panels on each side.

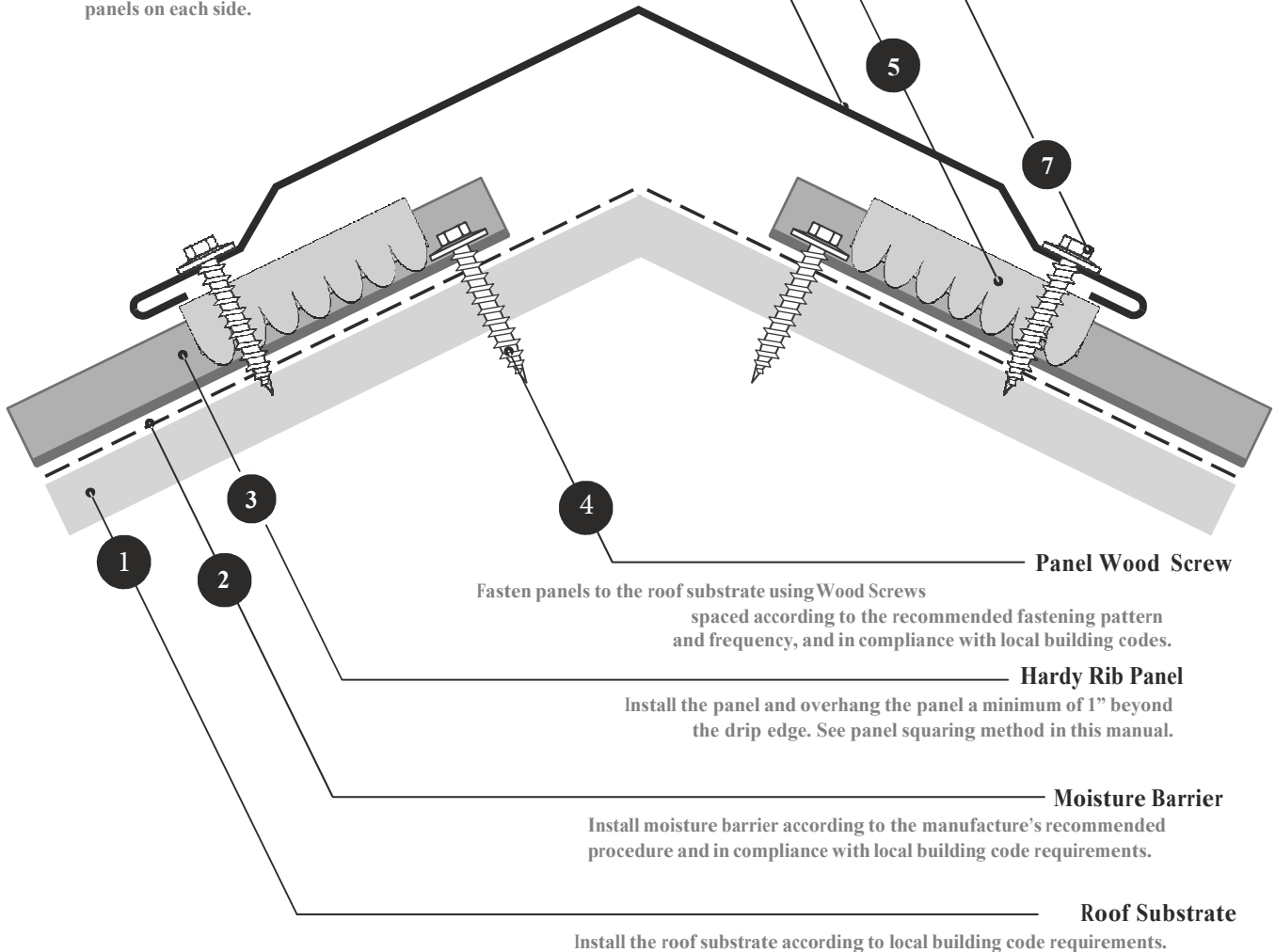

High Side Peak

Numbers indicate suggested trim assembly sequence.

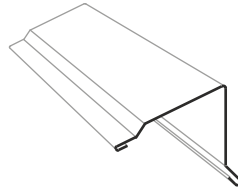

Trim Wood Screw

Fasten trim with Wood Screws spaced 2' apart along the length of the trim. See lapping diagram.

High Side Peak Trim

Place the High Side Peak Trim over the Outside Closure.

Trim Wood Screw

Fasten trim with Wood Screws spaced 9" apart along the length of the trim, through the rib. See lapping diagram.

Outside Closure

Place the Outside Closure over the panels.

Panel Wood Screw

Fasten panels to the roof substrate using Wood Screws spaced according to the recommended fastening pattern and frequency, and in compliance with local building codes.

Hardy Rib Panel

Install the panel and overhang the panel a minimum of 1" beyond the drip edge. See panel squaring method in this manual.

Moisture Barrier

Install moisture barrier according to the manufacturer's recommended procedure and in compliance with local building code requirements.

Roof Substrate

Install the roof substrate according to local building code requirements.

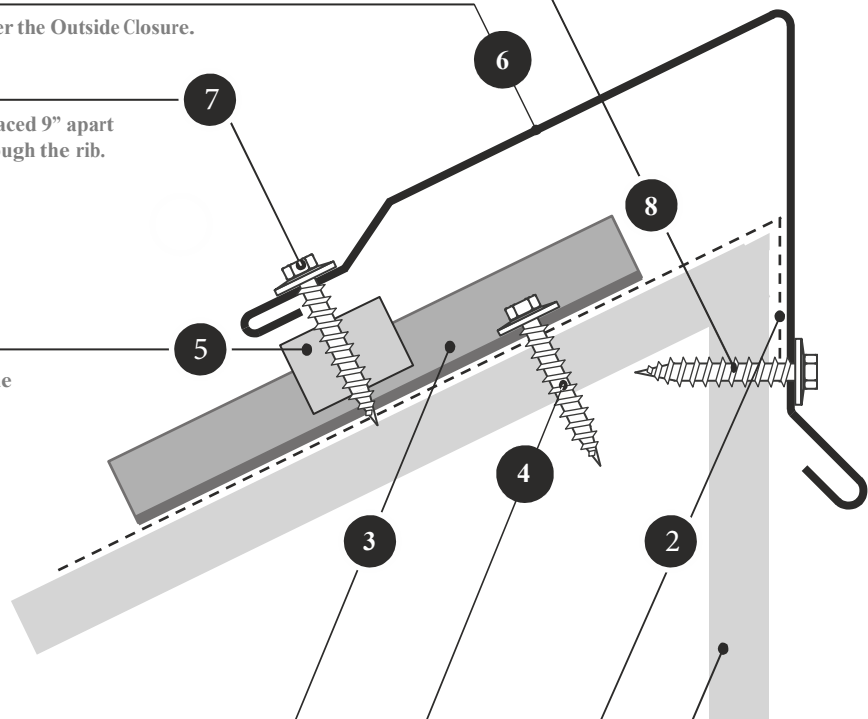

Side Wall

Numbers indicate suggested trim assembly sequence.

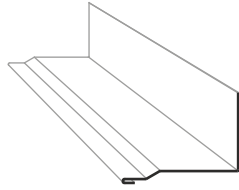

Tube Sealant

Apply Tube Sealant continuously along the Counter Flashing and generously filling the space between the flashing and the wall. Round or slope the Sealant top so that water will run off.

Trim Wood Screw

Fasten trim with Wood Screws spaced 2' apart along the length of the trim.

Counter Flashing (optional)

Position the Counter Flashing above the Side Wall Trim as shown. Some applications may not need counter flashing.

Side Wall Trim

Place the Side Wall Trim over the Butyl tape and overlap the ends 4". See lapping diagram in this manual.

Trim Wood Screw

Fasten trim with Wood Screws spaced 2' apart along the length of the trim. See lapping diagram.

Tape Sealant

Apply Butyl Tape along the length of the panel.

Panel Wood Screw

Fasten panels to the roof substrate using Wood Screws spaced according to the recommended fastening pattern and frequency, and in compliance with local building codes.

Hardy Rib Panel

Install the panel and overhang the panel a minimum of 1" beyond the drip edge. See panel squaring method in this manual.

Moisture Barrier

Install moisture barrier according to the manufacturer's recommended procedure and in compliance with local building code requirements.

Roof Substrate

Install the roof substrate according to local building code requirements.

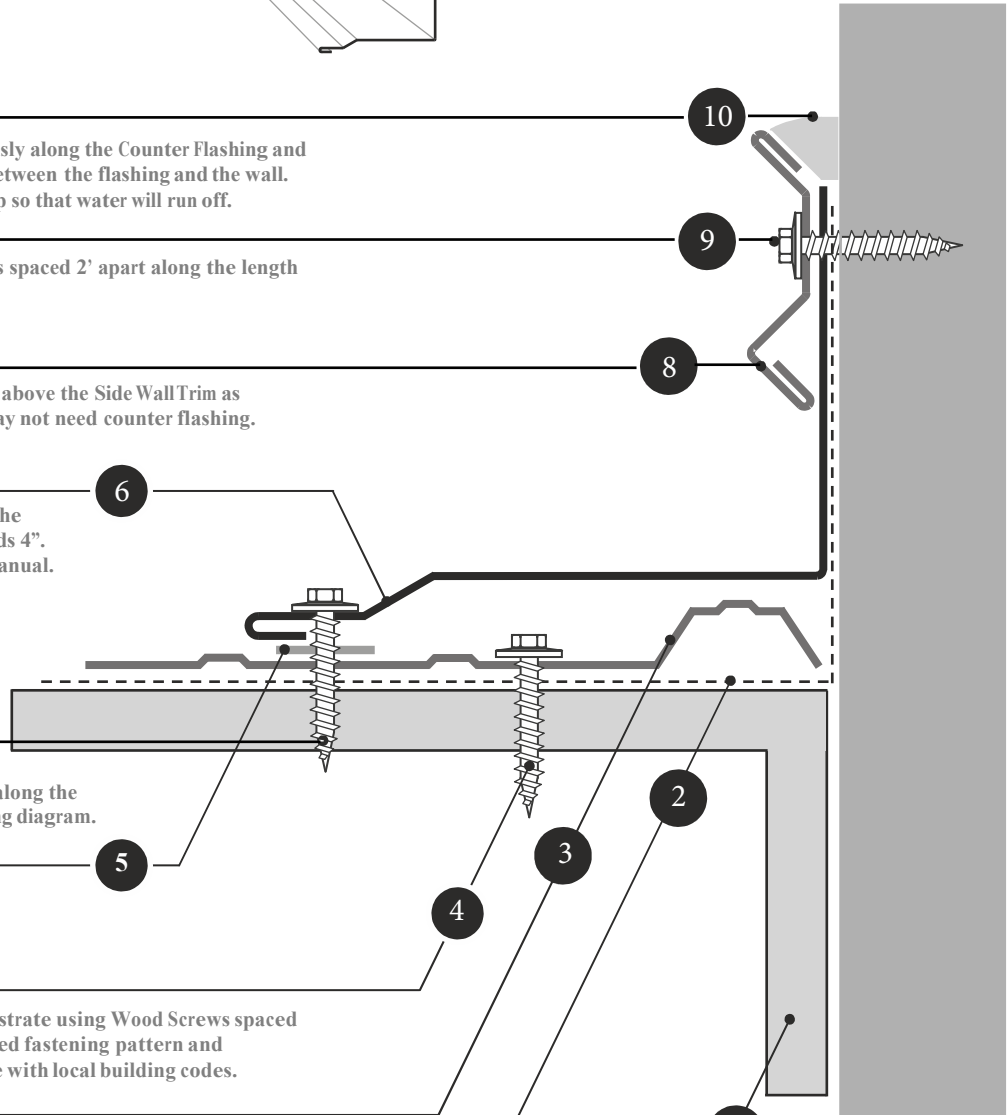

End Wall

Numbers indicate suggested trim assembly sequence.

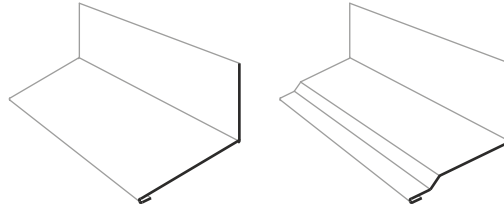

Tube Sealant

Apply Tube Sealant continuously along the Counter Flashing and generously filling the space between the flashing and the wall. Round or slope the Sealant top so that water will run off.

Trim Wood Screw

Fasten trim with Wood Screws spaced 2' apart along the length of the trim.

Counter Flashing

Position the Counter Flashing above the Side Wall Trim as shown. Some applications may not need counter flashing.

Side Wall Trim

Place the End Wall Trim over the Butyl tape and overlap the ends 4". See lapping diagram in this manual.

Outside Closure

Place the Outside Closure over the top of the panel.

Trim Wood Screw

Fasten trim with Wood Screws spaced 9" apart along the length of the trim, through the rib. See lapping diagram.

Hardy Rib Panel

Install the panel and overhang the panel a minimum of 1" beyond the drip edge. See panel squaring method in this manual.

Moisture Barrier

Install moisture barrier according to the manufacturer's recommended procedure.

Roof Substrate

Install the roof substrate according to local building code requirements.

Panel Wood Screw

Fasten panels to the roof substrate using Wood Screws spaced according to the recommended fastening pattern and frequency, and in compliance with local building codes.

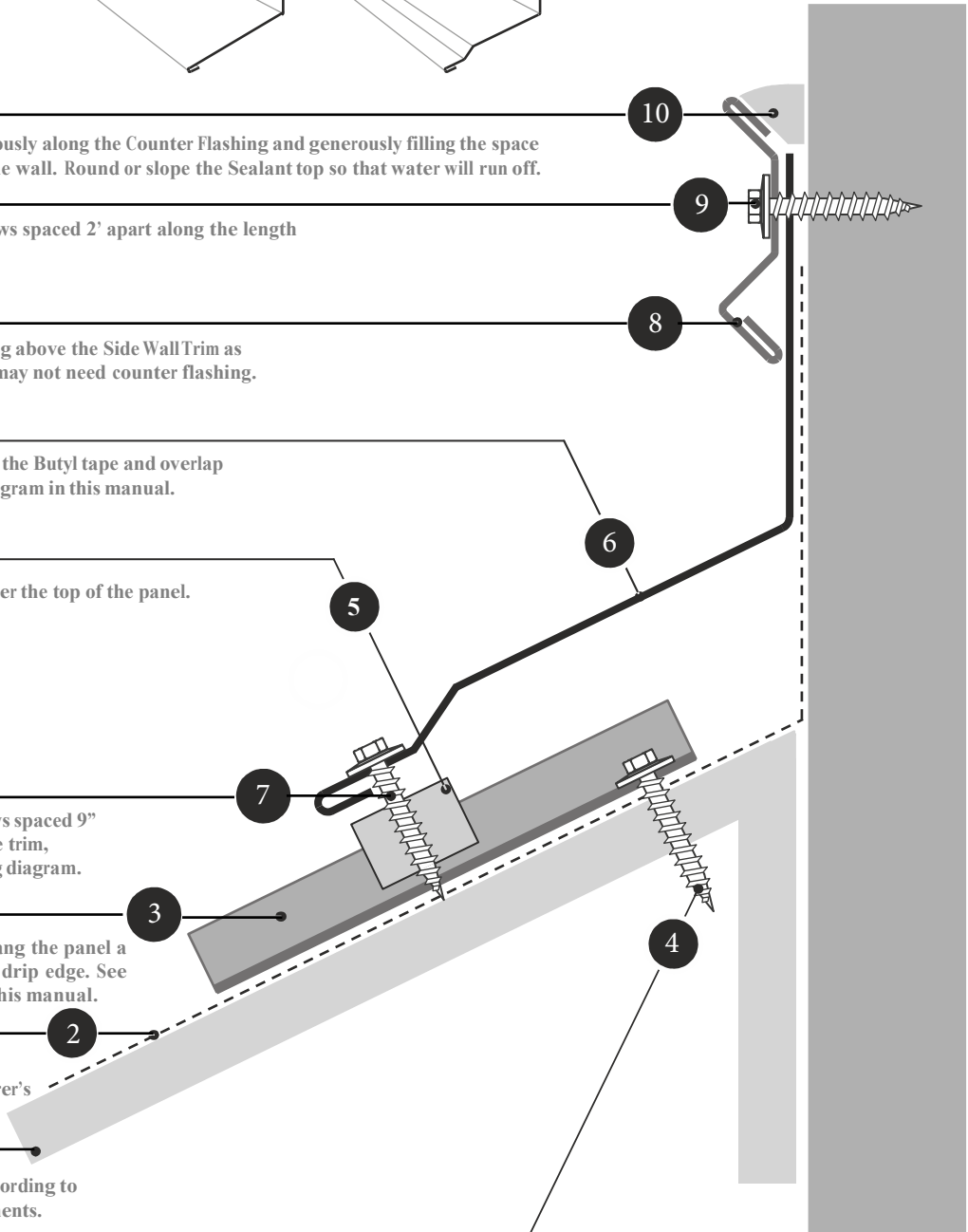

Valley Lapping

↓ After cutting notches and applying Tube Sealant, slide the up slope valley into the hem groove while lapping over the top of the low slope valley 4". ↓

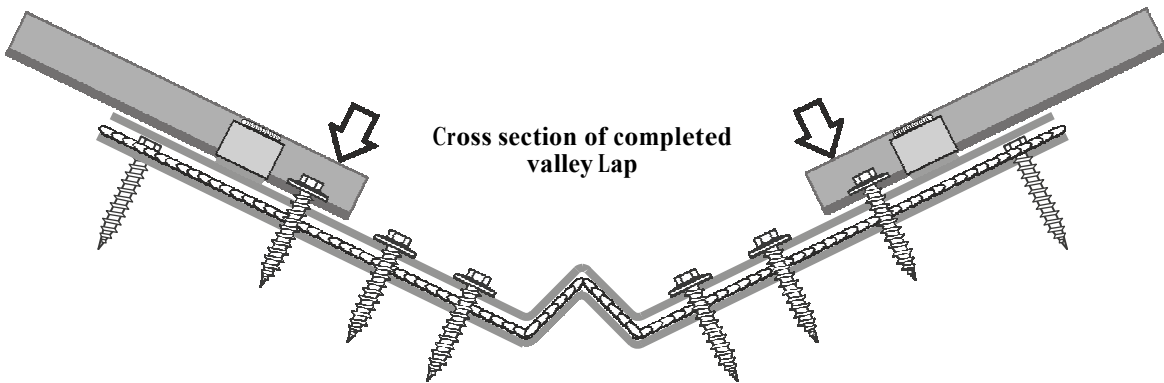
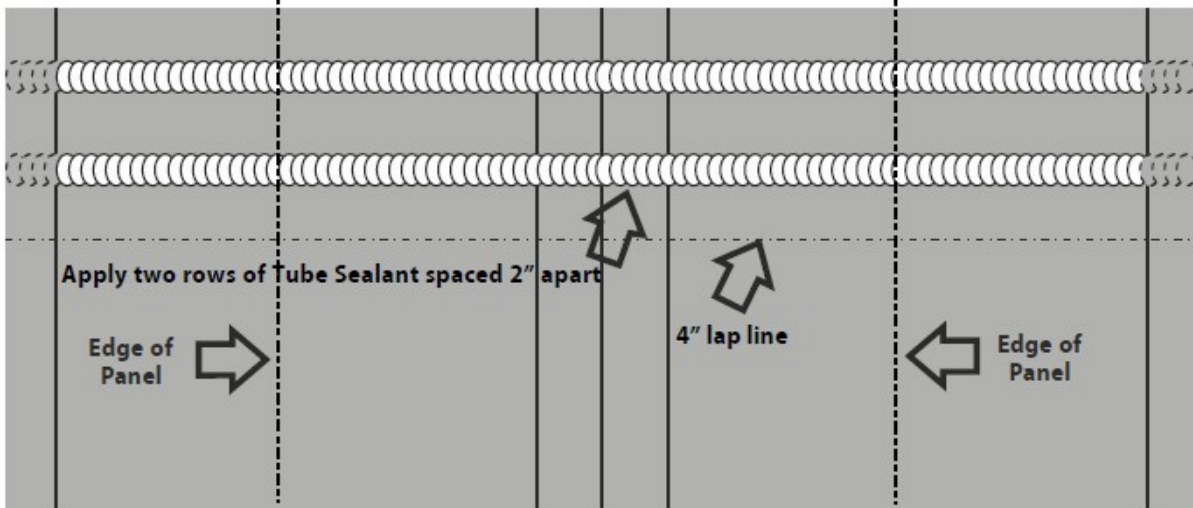
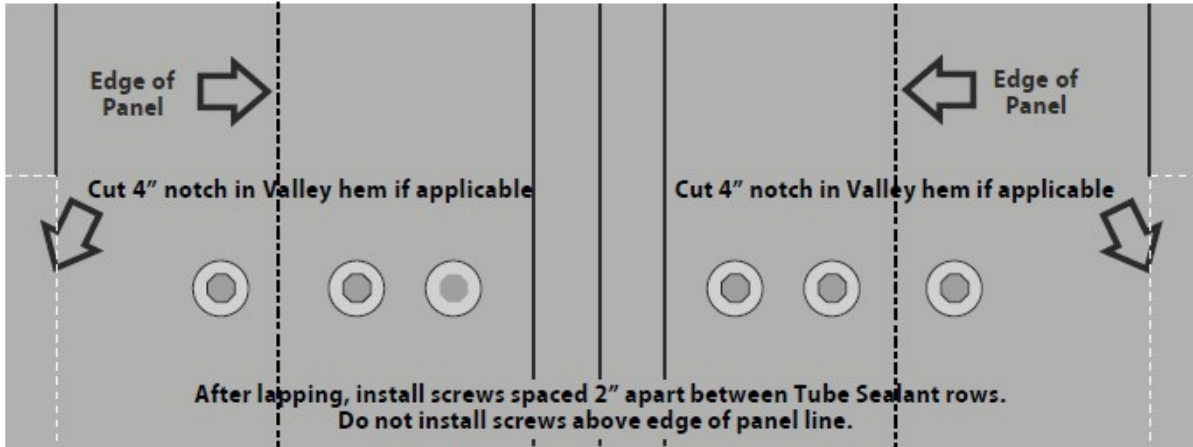

Valley Cutting

Valley starter cutting diagram with water diverter tabs.

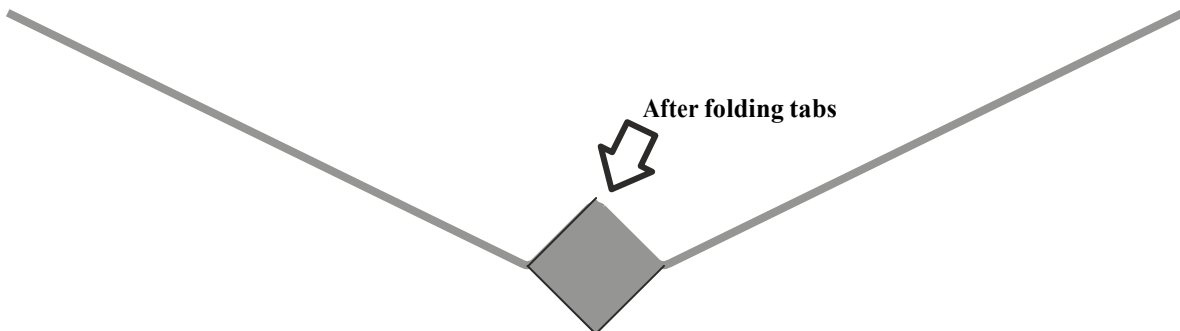
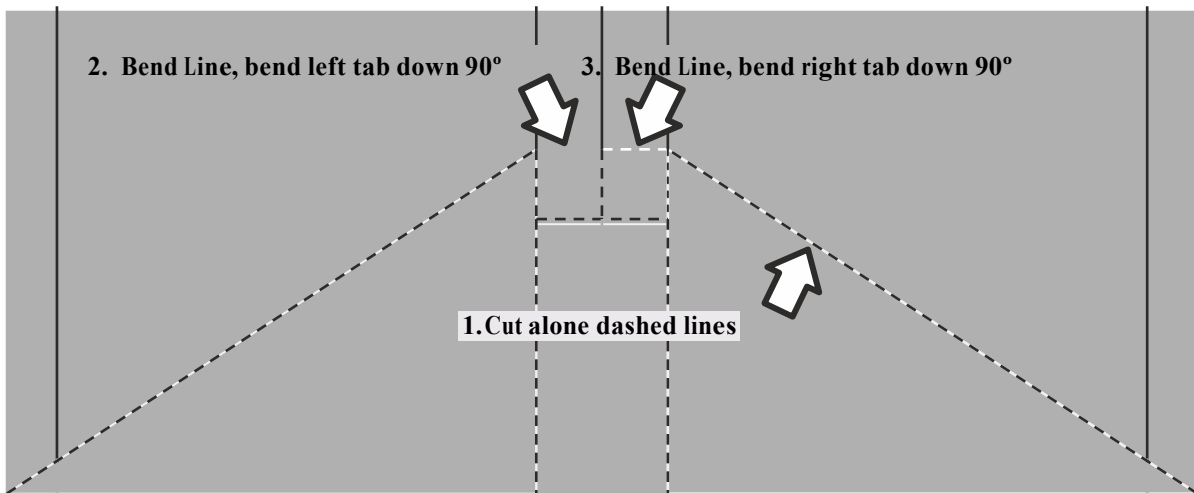
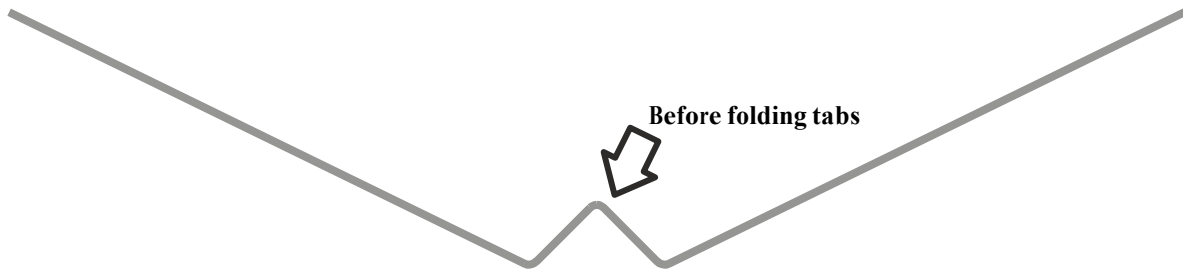

Pipe Flashing

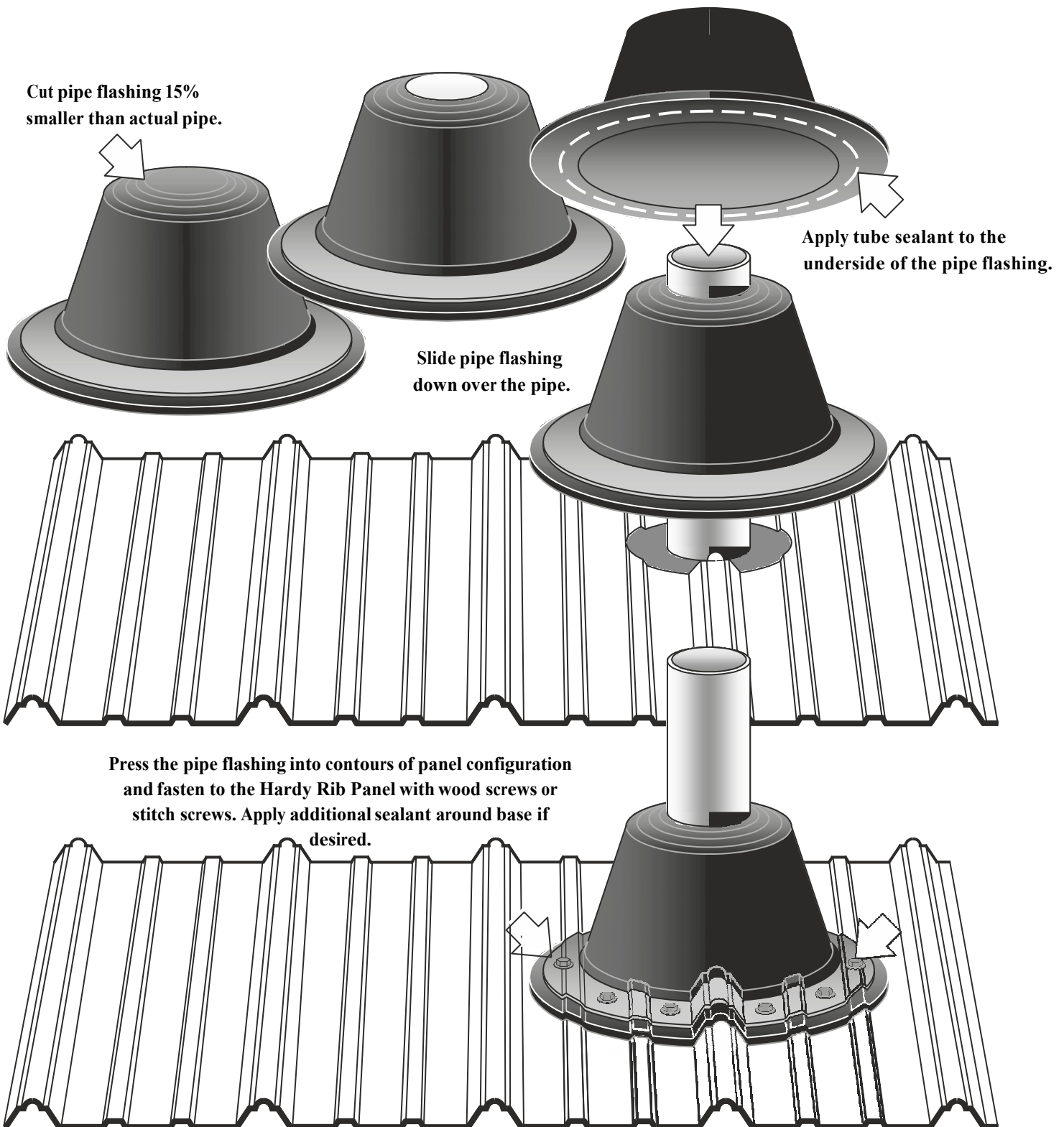



Mid Michigan Metal Sales
G3336 S Dort Hwy. Burton, MI. 48529 (800) 615-8416

Manufactures of High quality Metal Roofing and Siding Products
