

HardyRib & EconoRib Trims

We can also bend custom trims.

Tolerance of 1/8" plus or minus on ALL TRIMS.

All trims made 10ft 2in, unless otherwise noted.

Hardy Rib Trims

New Construction Drip Edge 10'

Used for Tear offs or New Construction Roofs

1x3 Drip Edge 10'

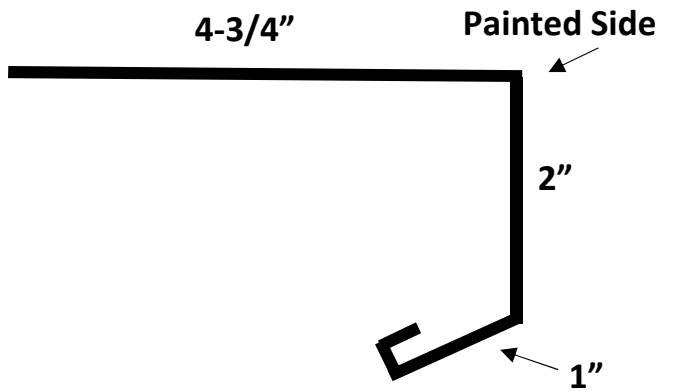
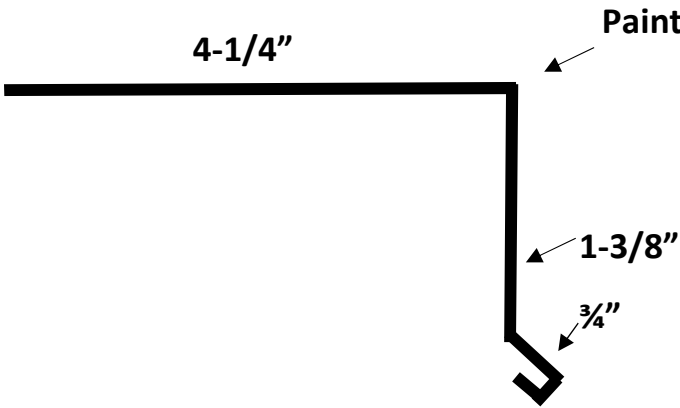

!

 " # \$ %"

\$ " / Gable

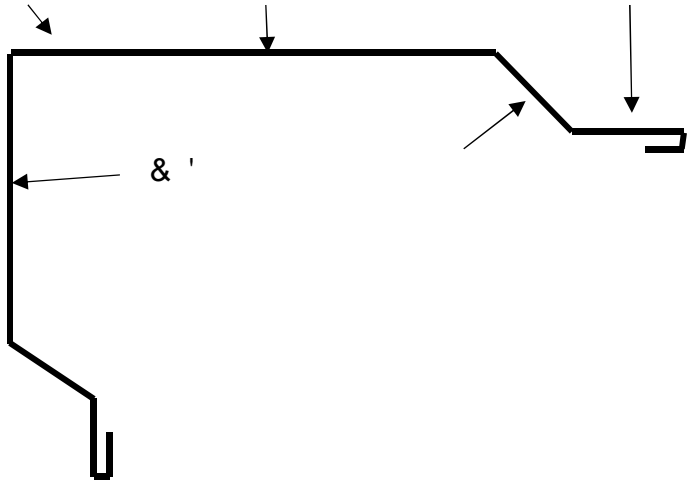
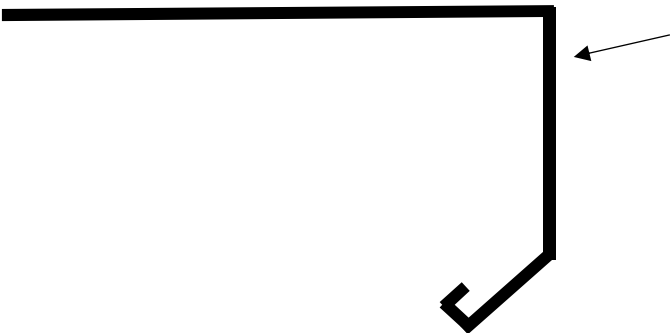

Hardy Rib trims

2x4 Drip Edge 10'

Special Order Non-Returnable

4-3/4"

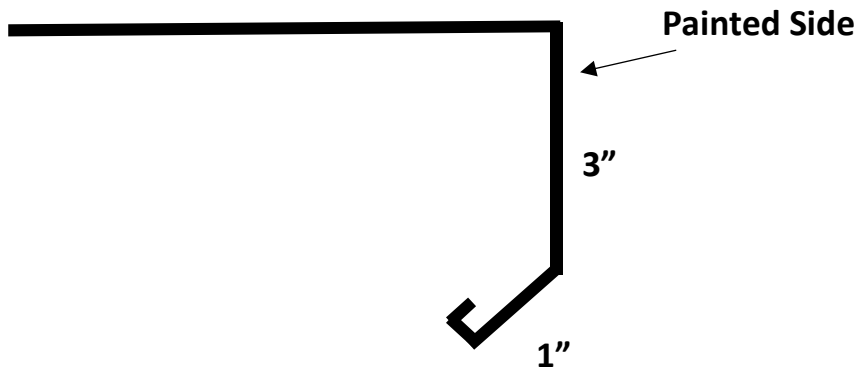

Residential Corner 10' or 12'

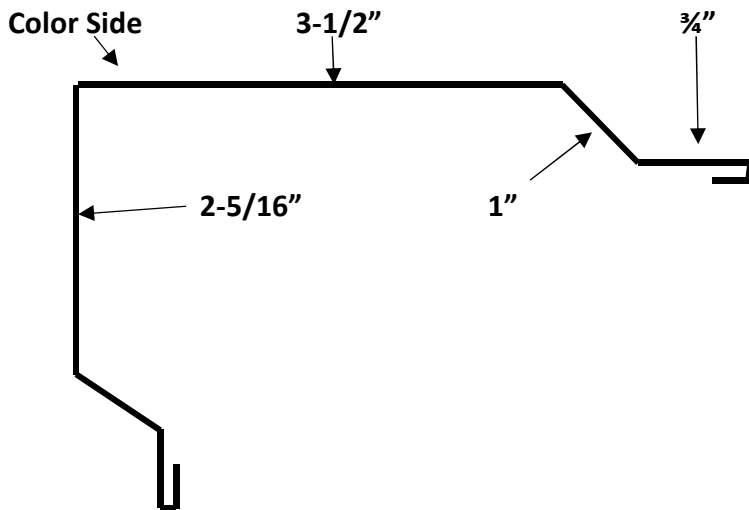

Hardy Rib Trims

Ridge Cap

10' or 12' Lengths

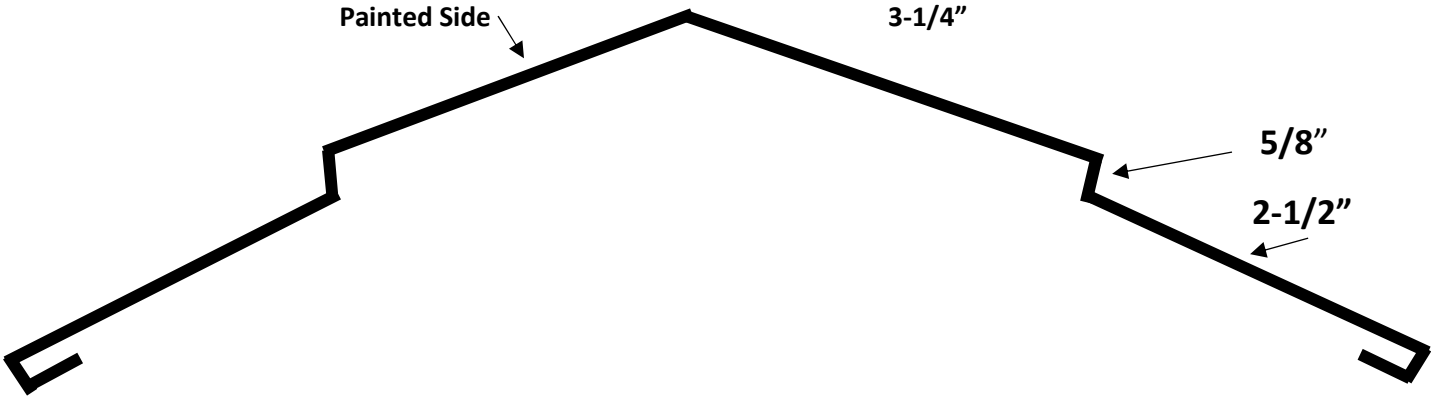

Corner/Gable Trim

10' and 12' in-stock

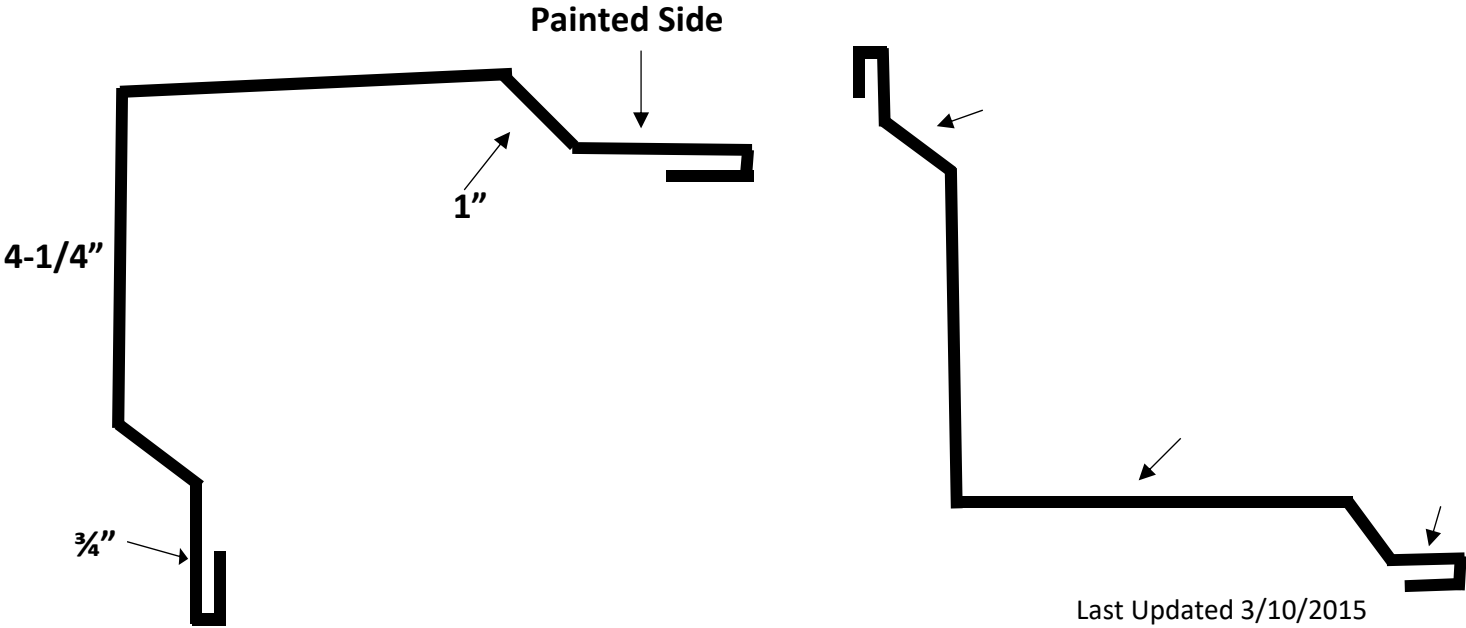

Hardy Rib Trims

Residential Rake 10' Non-Returnable

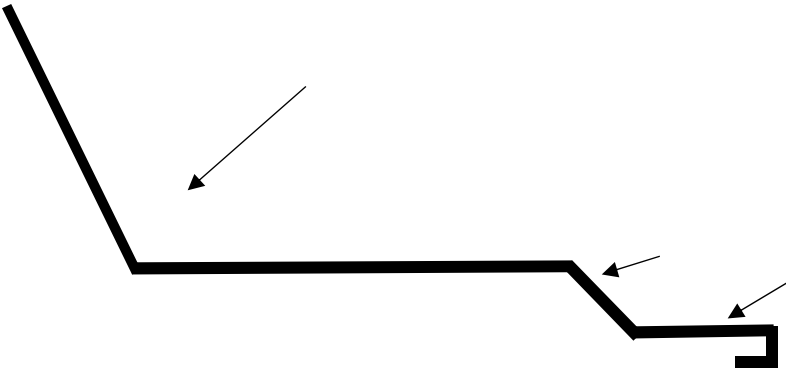
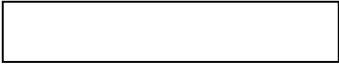
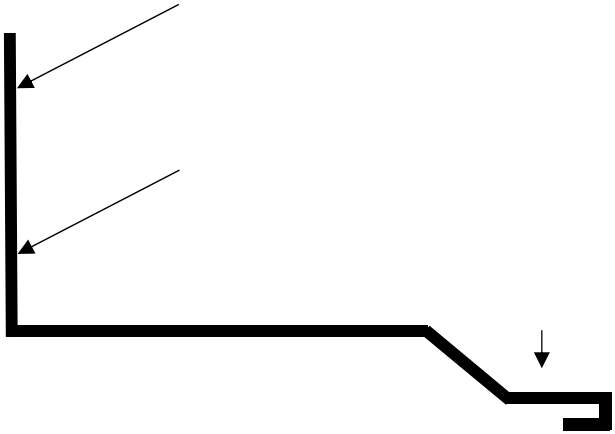
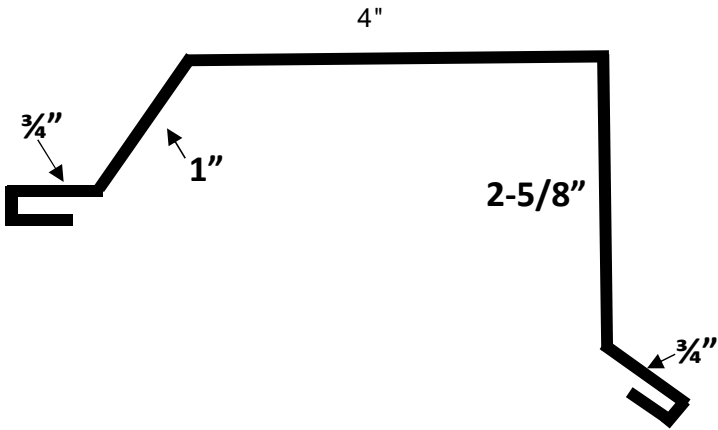
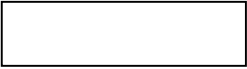

Hardy Rib Trims

Side Wall 10'

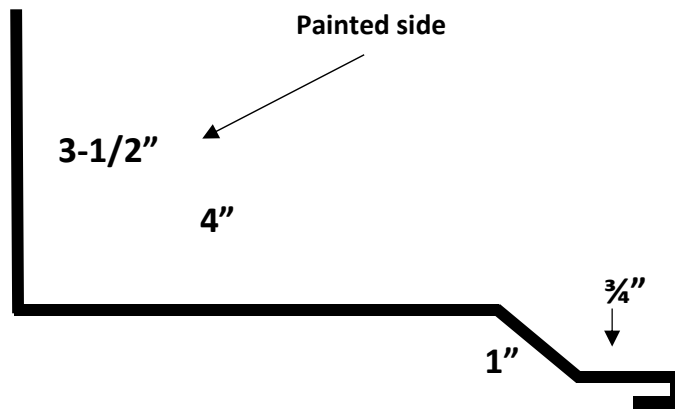

End/Head Wall 10'

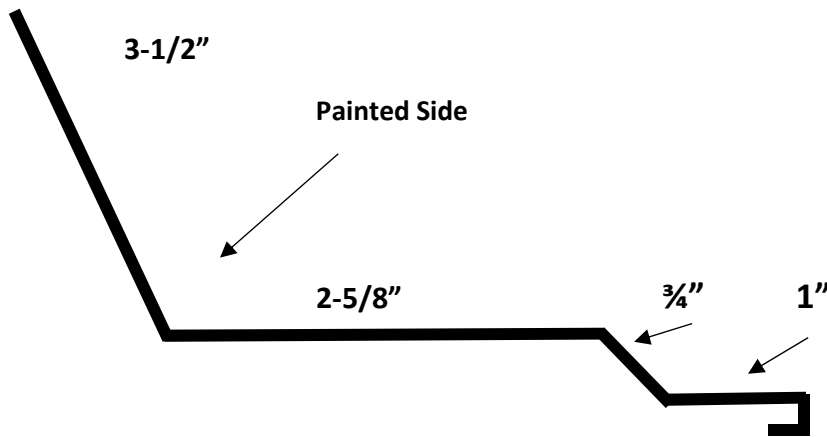

Hardy Rib Trims

Valley Pan 10' Non-Returnable

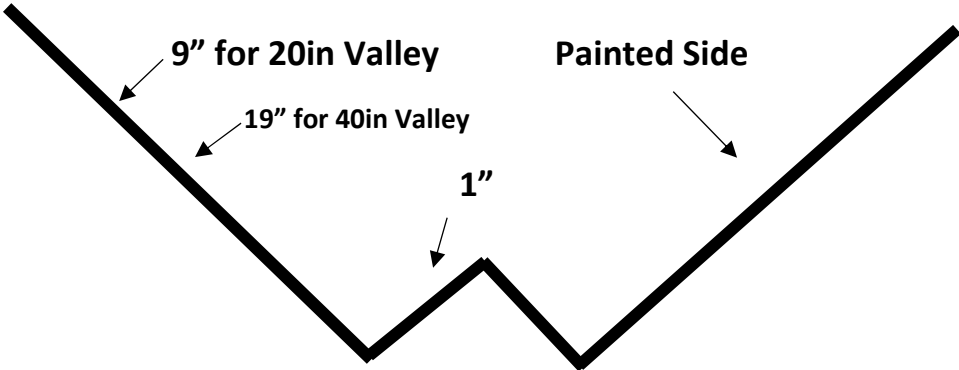

Inside Transition 10' Non-Returnable

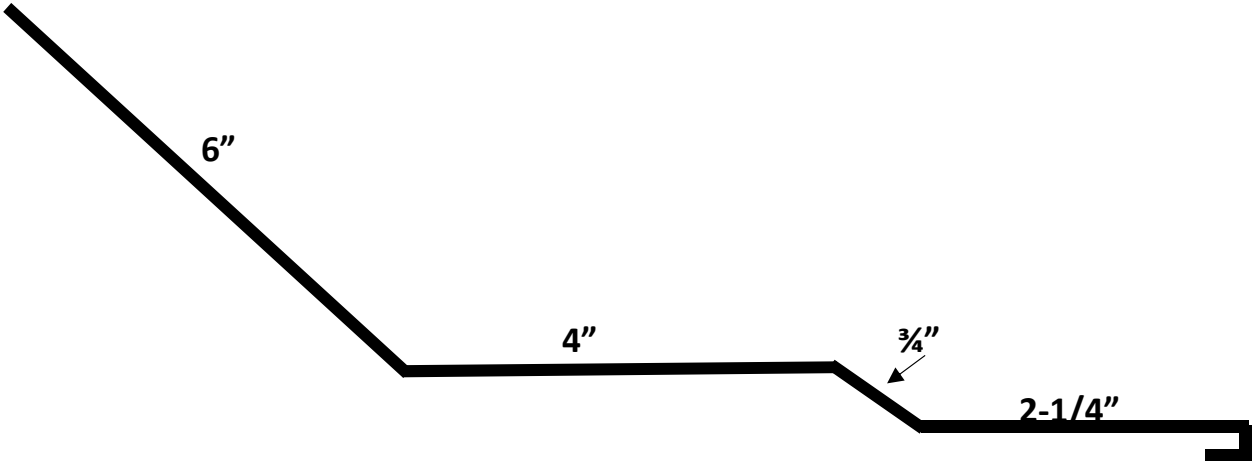

Hardy Rib Trims

Outside Transition 10' Non-Returnable

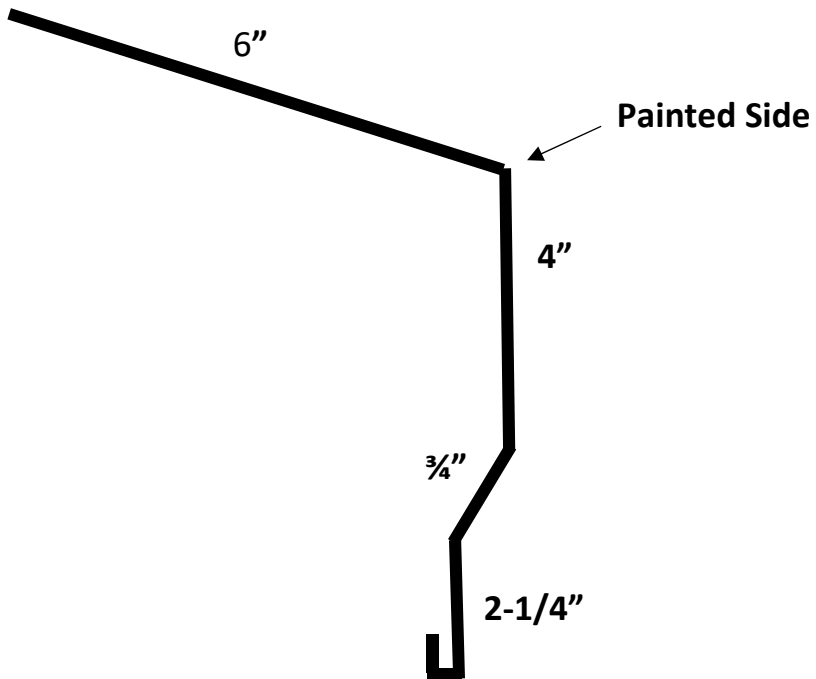

Z Bar 10'

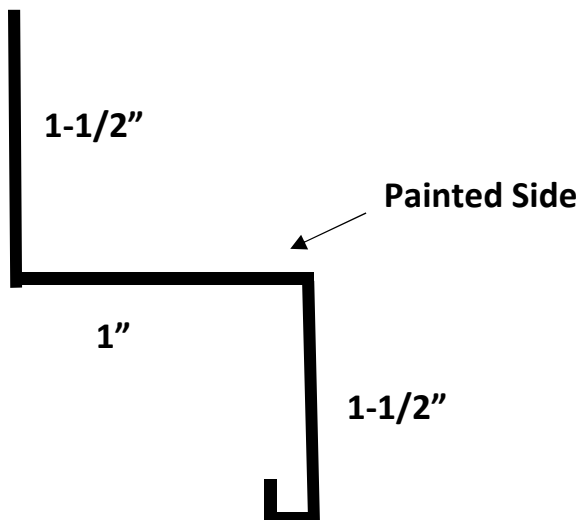

Hardy Rib Trims

J Channel 10'

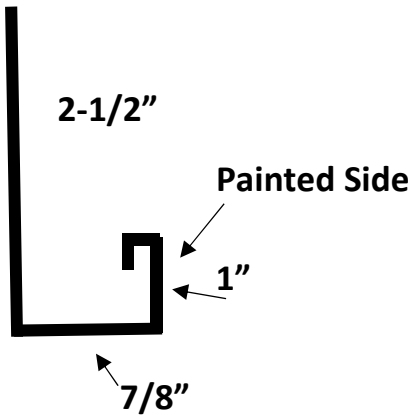

Soffit Angle 10'

Soffit angle is commonly used with J-channel to create an FJ for Soffit.

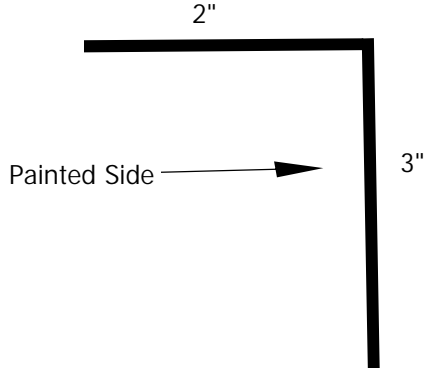

FJ Channel 10'

Non-Returnable

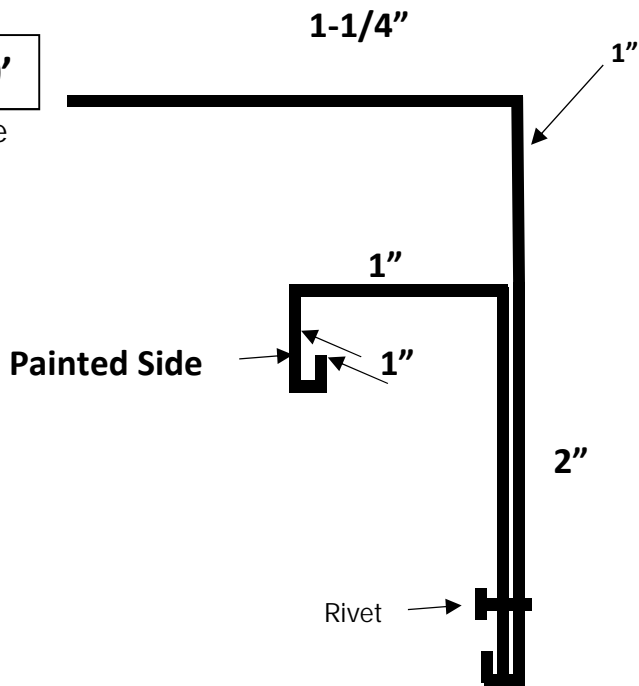

Hardy Rib Trims

Rat Guard 10'

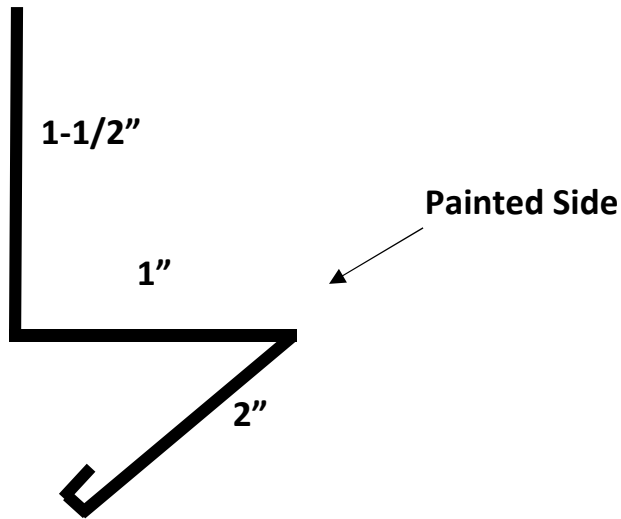

Snow Guard 10'

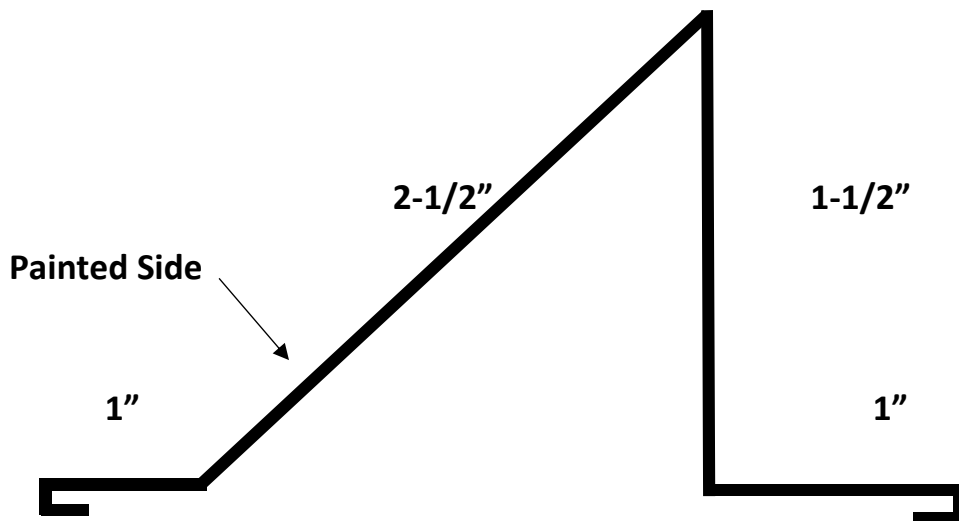

Hardy Rib Trims

Overhead Door Trim

NON-RETURNABLE

Available Lengths: 10 foot

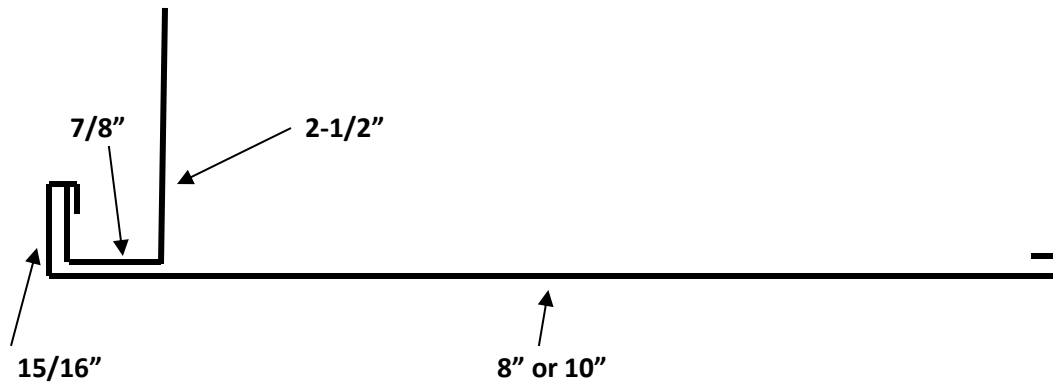

Fascia

Non-Returnable

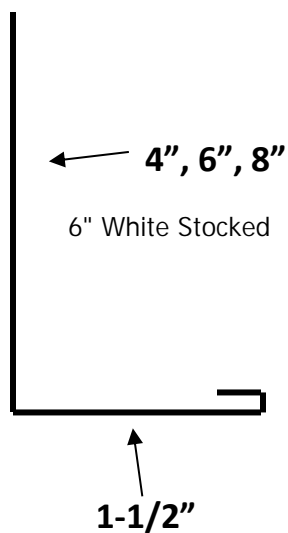

K-Style Steel Gutter

Non-Returnable

